

Basic Concepts

Tektronix

XYZs of Analog and Digital Oscilloscopes

070-8690-01

**RETURN THIS MANUAL
IF NOT RETURNED,
YOU WILL BE CHARGED
A MINIMUM OF \$50.00**

PLEASE RETURN TO:
TEKTRONIX CORPORATION
INSTRUMENT SERVICE
TEKNOLOGICAL DRIVE

23 March 85

Basic Concepts

Tektronix

XYZs of Analog and Digital Oscilloscopes

070-8690-01

Copyright © Tektronix, Inc., 1992, 1993. All rights reserved. Tektronix products are covered by U.S. and foreign patents, issued and pending. The following are registered trademarks: TEKTRONIX, TEK, TEKPROBE, and SCOPE-MOBILE.

Table of Contents

Introduction	1
Why Read This Book?	1
Need More Copies?	1
For More Information	2
The Oscilloscope	3
What Can You Do With It?	5
Analog and Digital	6
How Does an Oscilloscope Work?	7
Analog Oscilloscopes	7
Digital Oscilloscopes	8
Sampling Methods	10
Real-Time Sampling with Interpolation	10
Equivalent-Time Sampling	11
Oscilloscope Terminology	13
Measurement Terms	13
Types of Waves	15
Sine Waves	15
Square and Rectangular Waves	15
Sawtooth and Triangle Waves	16
Step and Pulse Shapes	16
Waveform Measurements	17
Frequency and Period	17
Voltage	17
Phase	18
Performance Terms	19
Bandwidth	19
Rise Time	19
Vertical Sensitivity	19
Sweep Speed	19
Gain Accuracy	19
Time Base or Horizontal Accuracy	19
Sample Rate	20
ADC Resolution (Or Vertical Resolution)	20
Record Length	20
Setting Up	21
Grounding	21
Ground the Oscilloscope	21
Ground Yourself	21
Setting the Controls	22

Probes	23
Using Passive Probes	24
Using Active Probes	25
Using Current Probes	25
Where to Clip the Ground Clip	25
Compensating the Probe	26
The Controls	29
Display Controls	29
Vertical Controls	29
Position and Volts per Division	30
Input Coupling	30
Bandwidth Limit	31
Channel Invert	31
Alternate and Chop Display	31
Math Operations	32
Horizontal Controls	33
Position and Seconds per Division	33
Time Base Selections	33
Trigger Position	34
Magnification	34
XY Mode	34
Trigger Controls	35
Trigger Level and Slope	36
Trigger Sources	36
Trigger Modes	37
Trigger Coupling	37
Trigger Holdoff	38
Acquisition Controls for Digital Oscilloscopes	39
Acquisition Modes	39
Stopping and Starting the Acquisition System	40
Sampling Methods	40
Other Controls	41
Measurement Techniques	43
The Display	43
Voltage Measurements	44
Time and Frequency Measurements	45
Pulse and Rise Time Measurements	46
Phase Shift Measurements	47
What's Next?	48
Written Exercises	49
Written Exercise Answers	58
Glossary	G-1
Index	I-1

Introduction

The oscilloscope is an essential tool if you plan to design or repair electronic equipment. It lets you “see” electrical signals.

Energy, vibrating particles, and other invisible forces are everywhere in our physical universe. Sensors can convert these forces into electrical signals that you can observe and study with an oscilloscope. Oscilloscopes let you “see” events that occur in a split second.

Why Read This Book?

If you are a scientist, engineer, technician, or electronics hobbyist, you should know how to use an oscilloscope. The concepts presented here provide you with a good starting point.

If you are using an oscilloscope for the first time, read this book to get a solid understanding of oscilloscope basics. Then, read the manual provided with your oscilloscope to learn specific information about how to use it in your work. After reading this book, you will be able to:

- Describe how oscilloscopes work
- Describe the difference between an analog and digital oscilloscope.
- Describe electrical waveform types
- Understand basic oscilloscope controls
- Take simple measurements

If you come across an unfamiliar term in this book, check the glossary in the back for a definition.

This book serves as a useful classroom aid. It includes vocabulary and multiple choice written exercises on oscilloscope theory and controls. You do not need any mathematical or electronics knowledge. This book emphasizes teaching you about oscilloscopes — how they work and how to make them work for you.

Need More Copies?

Additional copies of this book are available on request through your local Tektronix representative.

Individual copies are available by ordering part number 070–8690–01.

To order a packet of 50 copies (e.g., for classroom instruction), use part number 062–9323–01.

For More Information

If you have comments or questions about the material in this book, write to:
Tektronix, Inc.
P.O. Box 1520
Pittsfield, MA 01201

In the U.S., you may also call the Tektronix National Marketing Center toll
free:
1-800-426-2200

The Oscilloscope

What is an oscilloscope, what can you do with it, and how does it work? This section answers these fundamental questions.

The oscilloscope is basically a graph-displaying device — it draws a graph of an electrical signal. In most applications the graph shows how signals change over time: the vertical (Y) axis represents voltage and the horizontal (X) axis represents time. The intensity or brightness of the display is sometimes called the Z axis. (See Figure 1.) This simple graph can tell you many things about a signal. Here are a few:

- You can determine the time and voltage values of a signal.
- You can calculate the frequency of an oscillating signal.
- You can see the “moving parts” of a circuit represented by the signal.
- You can tell if a malfunctioning component is distorting the signal.
- You can find out how much of a signal is direct current (DC) or alternating current (AC).
- You can tell how much of the signal is noise and whether the noise is changing with time.

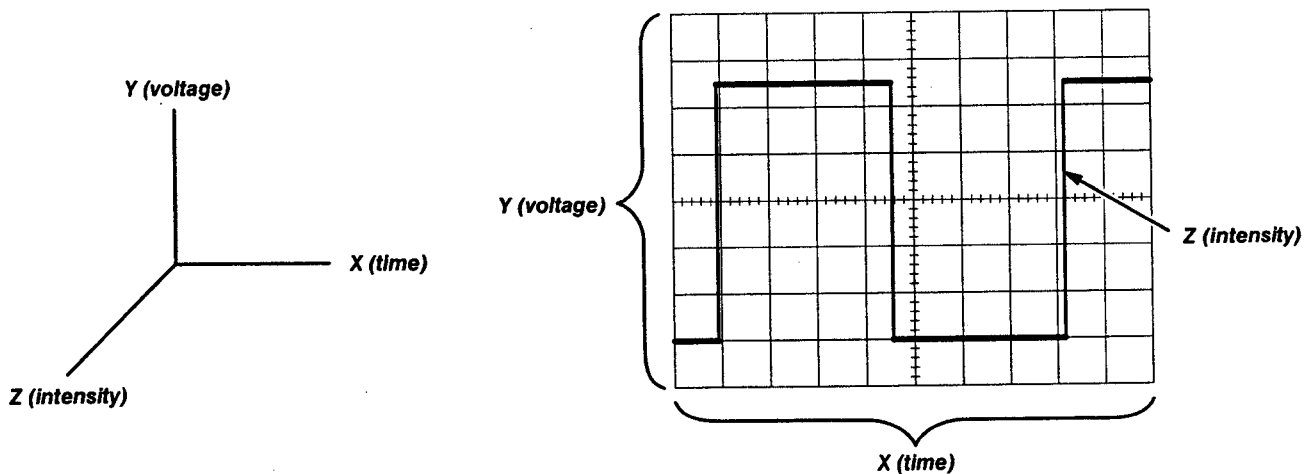

Figure 1: X, Y, and Z Components of a Displayed Waveform

An oscilloscope looks a lot like a small television set, except that it has a grid drawn on its screen and more controls than a television. The front panel of an oscilloscope normally has control sections divided into Vertical, Horizon-

tal, and Trigger sections. There are also display controls and input connectors. See if you can locate these front panel sections in Figures 2 and 3 and on your oscilloscope.

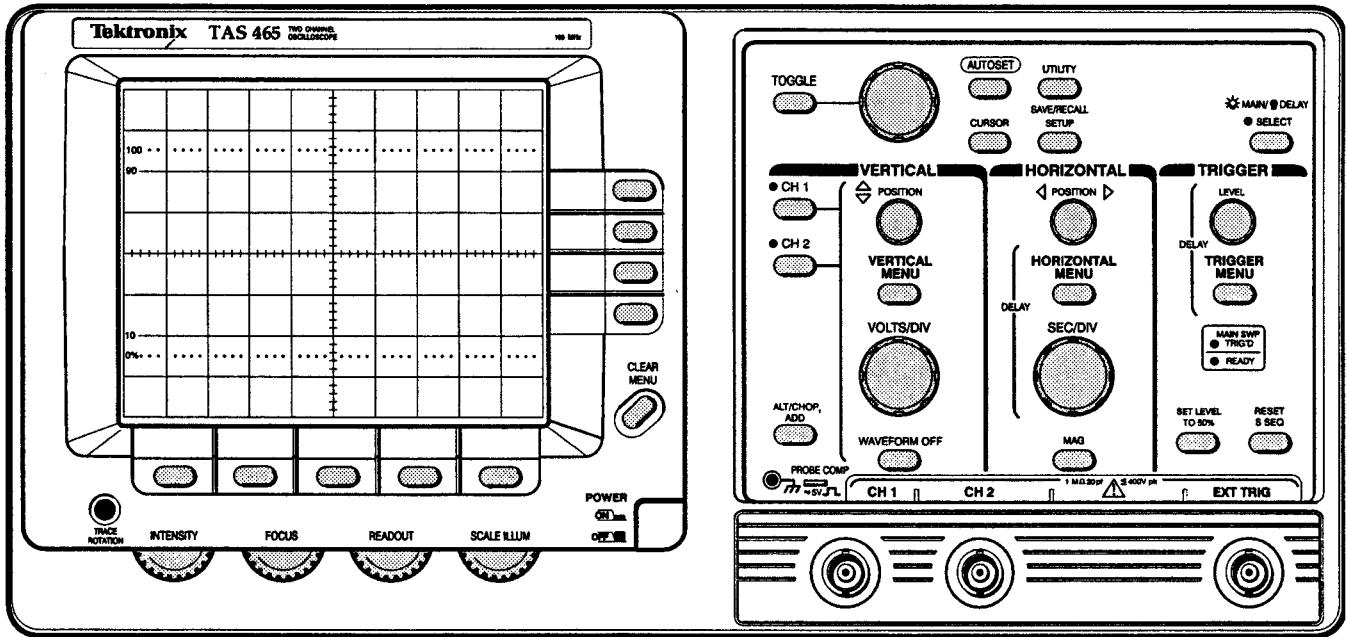

Figure 2: The TAS 465 Analog Oscilloscope Front Panel

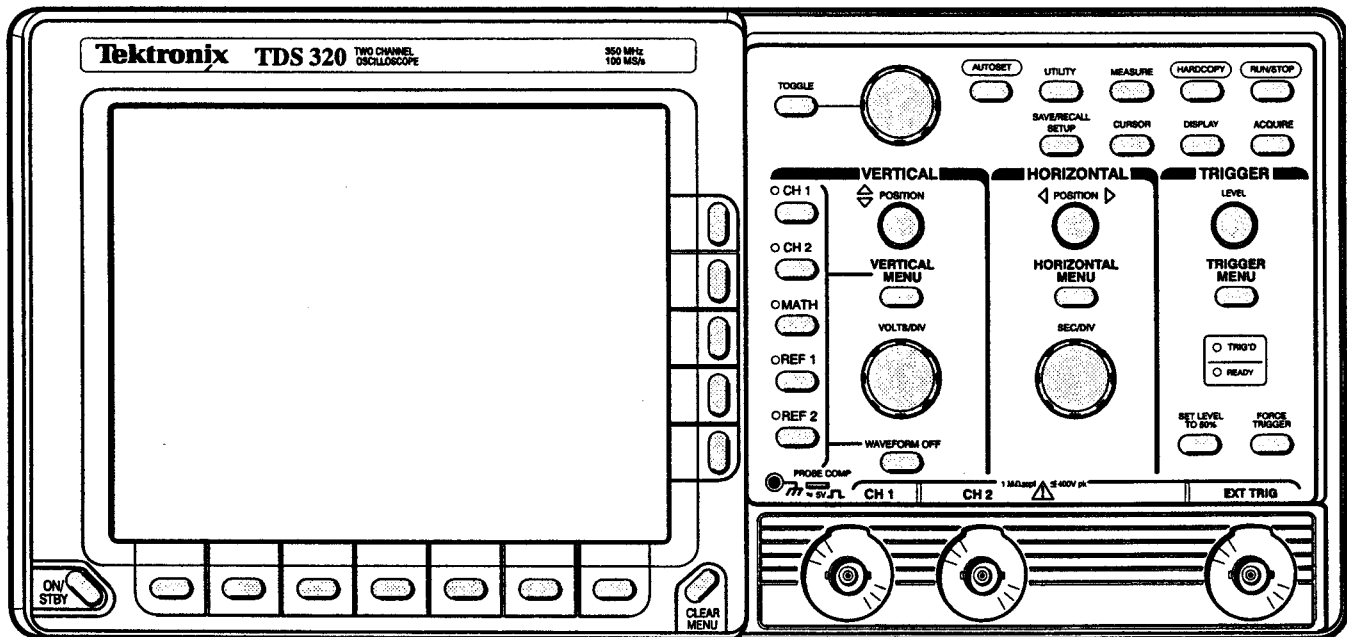

Figure 3: The TDS 320 Digital Oscilloscope Front Panel

What Can You Do With It?

Oscilloscopes are used by everyone from television repair technicians to physicists. They are indispensable for anyone designing or repairing electronic equipment.

The usefulness of an oscilloscope is not limited to the world of electronics. With the proper *transducer*, an oscilloscope can measure all kinds of phenomena. A transducer is a device that creates an electrical signal in response to physical stimuli, such as sound, mechanical stress, pressure, light, or heat. For example, a microphone is a transducer.

An automotive engineer uses an oscilloscope to measure engine vibrations. A medical researcher uses an oscilloscope to measure brain waves. The possibilities are endless.

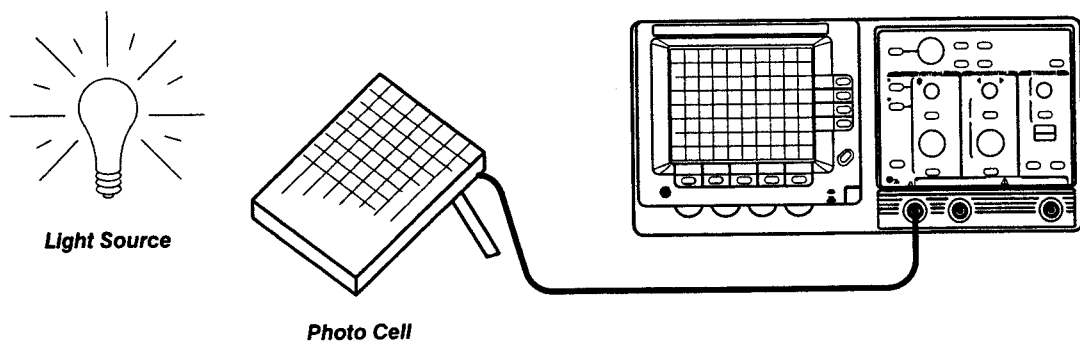

Figure 4: Scientific Data Gathered by an Oscilloscope

Analog and Digital

Electronic equipment can be divided into two types: analog and digital. *Analog* equipment works with continuously variable voltages, while *digital* equipment works with discrete binary numbers that may represent voltage samples. For example, a conventional phonograph turntable is an analog device; a compact disc player is a digital device.

Oscilloscopes also come in analog and digital types. An analog oscilloscope works by directly applying a voltage being measured to an electron beam moving across the oscilloscope screen. The voltage deflects the beam up and down proportionally, tracing the waveform on the screen. This gives an immediate picture of the waveform.

In contrast, a digital oscilloscope samples the waveform and uses an analog-to-digital converter (or ADC) to convert the voltage being measured into digital information. It then uses this digital information to reconstruct the waveform on the screen.

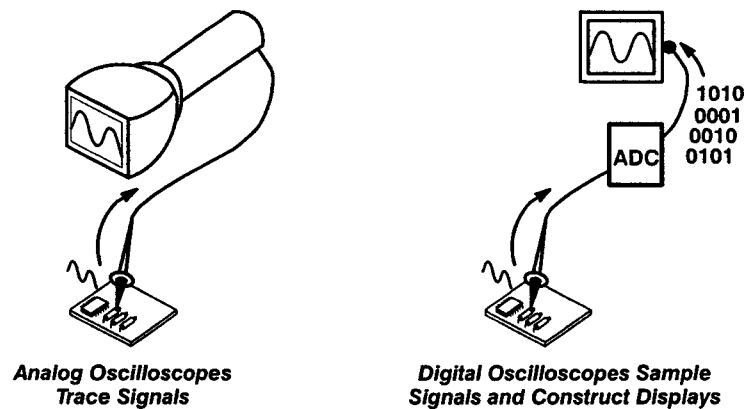

Figure 5: Digital and Analog Oscilloscopes Display Waveforms

For many applications either an analog or digital oscilloscope will do. However, each type does possess some unique characteristics making it more or less suitable for specific tasks.

People often prefer analog oscilloscopes when it is important to display rapidly varying signals in “real time” (or as they occur).

Digital oscilloscopes allow you to capture and view events that may happen only once. They can process the digital waveform data or send the data to a computer for processing. Also, they can store the digital waveform data for later viewing and printing.

How Does an Oscilloscope Work?

To better understand the oscilloscope controls, you need to know a little more about how oscilloscopes display a signal. Analog oscilloscopes work somewhat differently than digital oscilloscopes. However, several of the internal systems are similar. Analog oscilloscopes are somewhat simpler in concept and are described first, followed by a description of digital oscilloscopes.

Analog Oscilloscopes

When you connect an oscilloscope probe to a circuit, the voltage signal travels through the probe to the vertical system of the oscilloscope. Figure 6 is a simple block diagram that shows how an analog oscilloscope displays a measured signal.

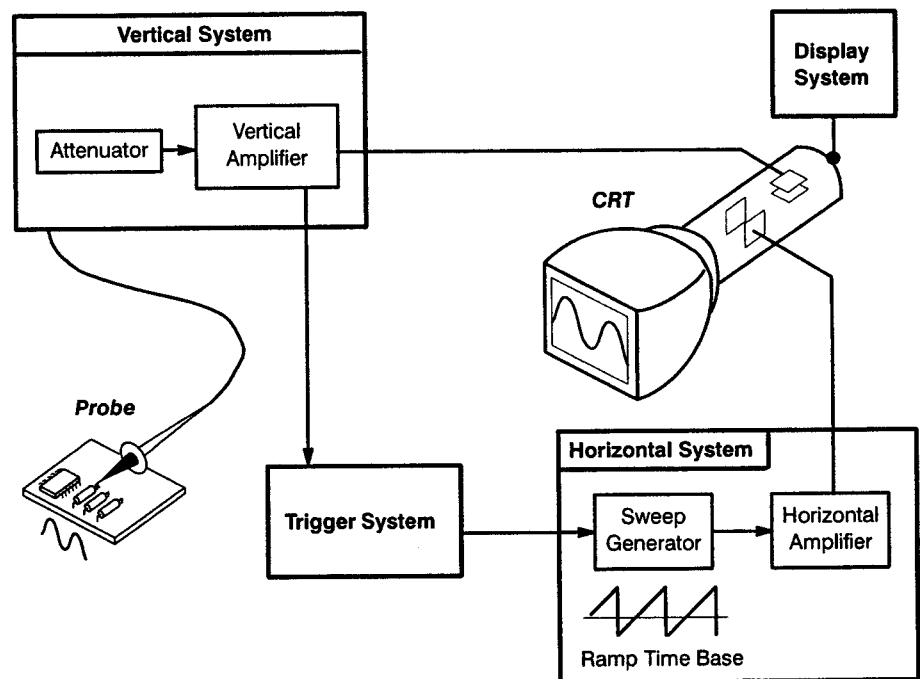

Figure 6: Analog Oscilloscope Block Diagram

Depending on how you set the vertical scale (volts/div control), an *attenuator* reduces the signal voltage or an *amplifier* increases the signal voltage.

Next, the signal travels directly to the vertical deflection plates of the cathode ray tube (CRT). Voltage applied to these deflection plates causes a glowing dot to move. (An electron beam hitting phosphor inside the CRT creates the glowing dot.) A positive voltage causes the dot to move up while a negative voltage causes the dot to move down.

The signal also travels to the trigger system to start or trigger a “horizontal sweep.” Horizontal sweep is a term referring to the action of the horizontal system causing the glowing dot to move across the screen. Triggering the

horizontal system causes the horizontal time base to move the glowing dot across the screen from left to right within a specific time interval. Many sweeps in rapid sequence cause the movement of the glowing dot to blend into a solid line. At higher speeds, the dot may sweep across the screen up to 500,000 times each second.

Together, the horizontal sweeping action and the vertical deflection action traces a graph of the signal on the screen. The trigger is necessary to stabilize a repeating signal. It ensures that the sweep begins at the same point of a repeating signal, resulting in a clear picture as shown in Figure 7.

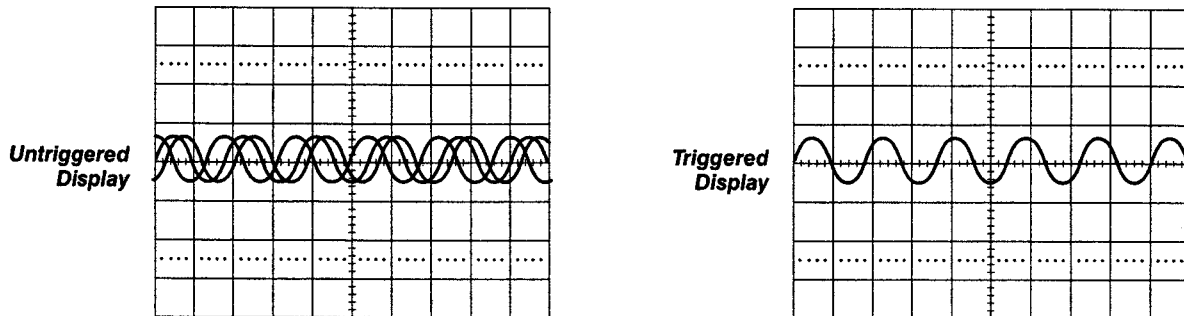

Figure 7: Triggering Stabilizes a Repeating Waveform

In conclusion, to use an analog oscilloscope, you need to adjust three basic settings to accommodate an incoming signal:

- The attenuation or amplification of the signal. Use the volts/div control to adjust the amplitude of the signal before it is applied to the vertical deflection plates.
- The time base. Use the sec/div control to set the amount of time per division represented horizontally across the screen.
- The triggering of the oscilloscope. Use the trigger level to stabilize a repeating signal, as well as triggering on a single event.

Also, adjusting the focus and intensity controls enables you to create a sharp, visible display.

Digital Oscilloscopes

Some of the systems that make up digital oscilloscopes are the same as those in analog oscilloscopes; however, digital oscilloscopes contain additional data processing systems. (See Figure 8.) With the added systems, the digital oscilloscope collects data for the entire waveform and then displays it.

When you attach a digital oscilloscope probe to a circuit, the vertical system adjusts the amplitude of the signal, just as in the analog oscilloscope.

Next, the analog-to-digital converter (ADC) in the acquisition system samples the signal at discrete points in time and converts the signal's voltage at these points to digital values called *sample points*. The horizontal system's

sample clock determines how often the ADC takes a sample. The rate at which the clock “ticks” is called the sample rate and is measured in samples per second.

The sample points from the ADC are stored in memory as *waveform points*. More than one sample point may make up one waveform point.

Together, the waveform points make up one *waveform record*. The number of waveform points used to make a waveform record is called the *record length*. The trigger system determines the start and stop points of the record. The display receives these record points after being stored in memory.

Depending on the capabilities of your oscilloscope, additional processing of the sample points may take place, enhancing the display. Pretrigger may be available, allowing you to see events before the trigger point.

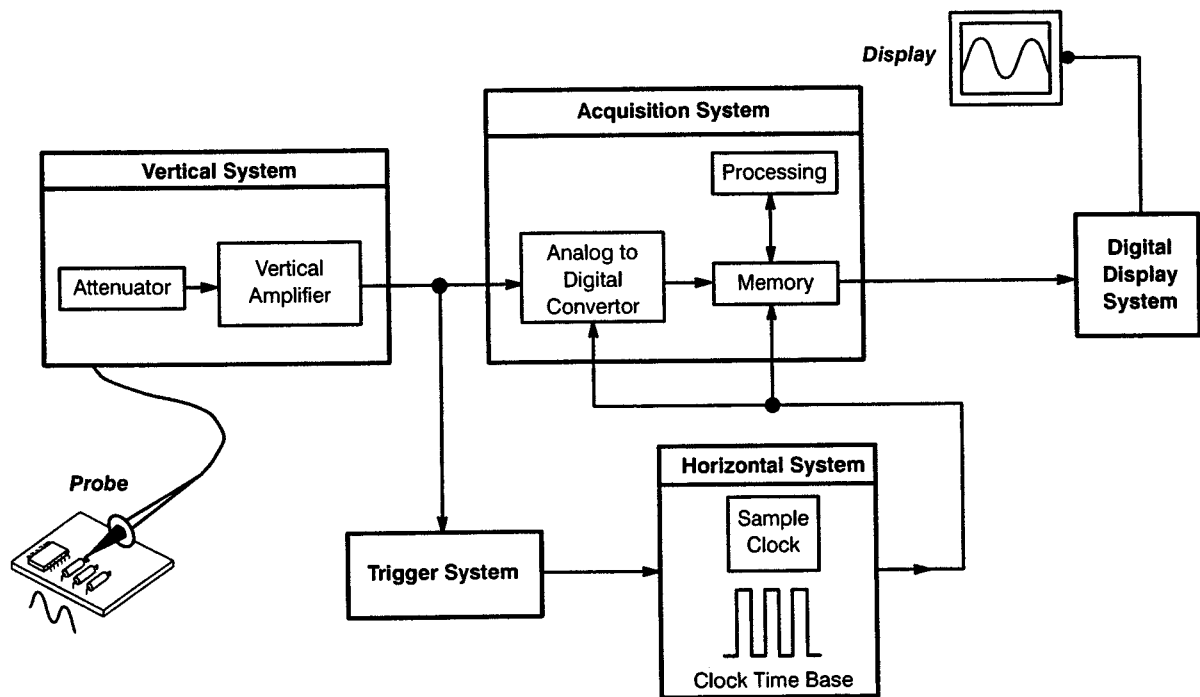

Figure 8: Digital Oscilloscope Block Diagram

Fundamentally, with a digital oscilloscope as with an analog oscilloscope, you need to adjust the vertical, horizontal, and trigger settings to take a measurement.

Sampling Methods

The sampling method tells the digital oscilloscope how to collect sample points. For slowly changing signals, a digital oscilloscope easily collects more than enough sample points to construct an accurate picture. However, for faster signals, (how fast depends on the oscilloscope's maximum sample rate) the oscilloscope cannot collect enough samples. The digital oscilloscope can do two things:

- It can collect a few sample points of the signal in a single pass (in *real-time* sampling mode) and then use *interpolation*. Interpolation is a processing technique to estimate what the waveform looks like based on a few points.
- It can build a picture of the waveform over time, as long as the signal repeats itself (*equivalent-time* sampling mode).

Real-Time Sampling with Interpolation

Digital oscilloscopes use real-time sampling as the standard sampling method. In real-time sampling, the oscilloscope collects as many samples as it can as the signal occurs. (See Figure 9.) For single-shot or transient signals you must use real time sampling.

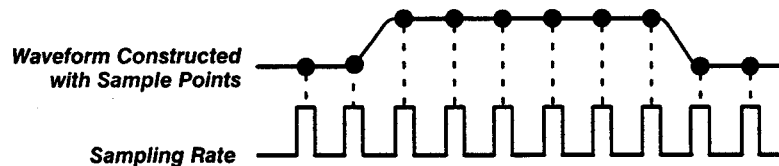

Figure 9: Real-time Sampling

Digital oscilloscopes use interpolation to display signals that are so fast that the oscilloscope can only collect a few sample points. Interpolation “connects the dots.”

Linear interpolation simply connects sample points with straight lines. Sine interpolation (or *sin x over x* interpolation) connects sample points with curves. (See Figure 10.) *Sin x over x* interpolation is a mathematical process similar to the “oversampling” used in compact disc players. With sine interpolation, points are calculated to fill in the time between the real samples. Using this process, a signal that is sampled only a few times in each cycle can be accurately displayed or, in the case of the compact disc player, accurately played back.

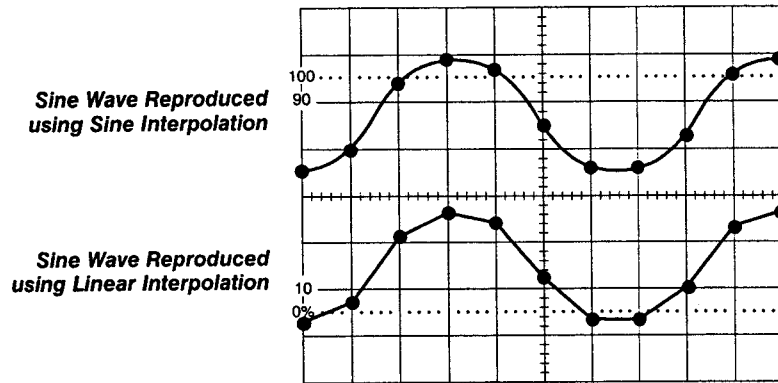

Figure 10: Linear and Sine Interpolation

Equivalent-Time Sampling

Some digital oscilloscopes can use equivalent-time sampling to capture very fast repeating signals. Equivalent-time sampling constructs a picture of a repetitive signal by capturing a little bit of information from each repetition. (See Figure 11.) You see the waveform slowly build up like a string of lights going on one-by-one. With *sequential sampling* the points appear from left to right in sequence; with *random sampling* the points appear randomly along the waveform.

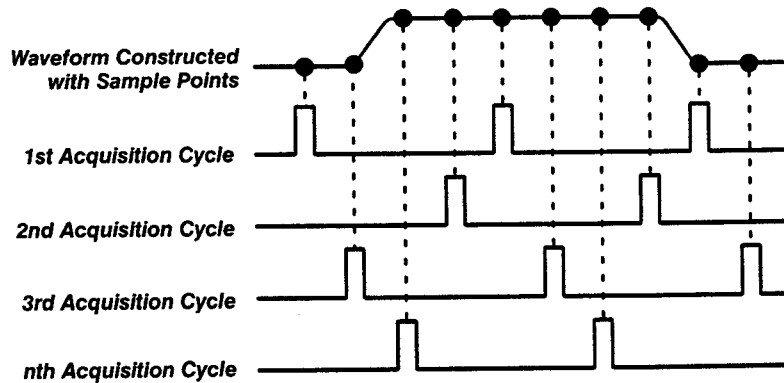

Figure 11: Equivalent-time Sampling

Oscilloscope Terminology

Learning a new skill often involves learning a new vocabulary. This idea holds true for learning how to use an oscilloscope. This section describes some useful measurement and oscilloscope performance terms.

Measurement Terms

The generic term for a pattern that repeats over time is a *wave* — sound waves, brain waves, ocean waves, and voltage waves are all repeating patterns. An oscilloscope measures voltage waves. One *cycle* of a wave is the portion of the wave that repeats. A *waveform* is a graphic representation of a wave. A voltage waveform shows time on the horizontal axis and voltage on the vertical axis.

Waveform shapes tell you a great deal about a signal. Any time you see a change in the height of the waveform, you know the voltage has changed. Any time there is a flat horizontal line, you know that there is no change for that length of time. Straight diagonal lines mean a linear change — rise or fall of voltage at a steady rate. Sharp angles on a waveform mean sudden change. Figure 12 shows common waveforms and Figure 13 shows some common sources of waveforms.

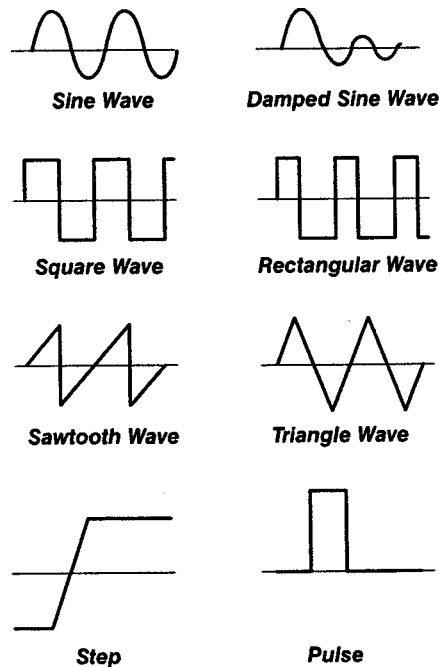

Figure 12: Common Waveforms

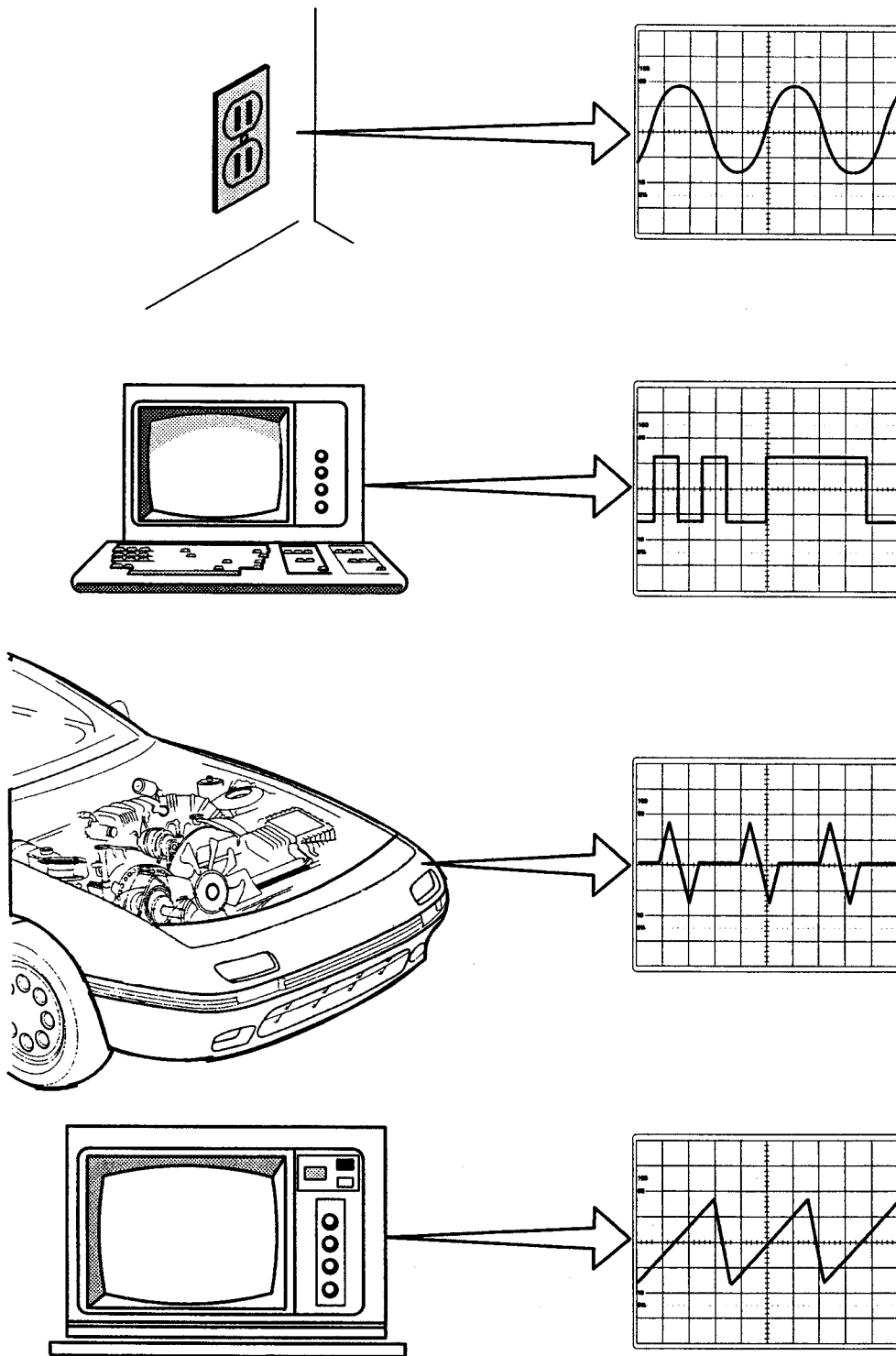

Figure 13: Sources of Common Waveforms

Types of Waves

You can classify most waves into these types:

- Sine waves
- Square and rectangular waves
- Triangle and sawtooth waves
- Step and pulse shapes

Sine Waves

The *sine wave* is the fundamental wave shape for several reasons. It has harmonious mathematical properties — it is the same sine shape you may have studied in high school trigonometry class. The voltage in your wall outlet varies as a sine wave. Test signals produced by the oscillator circuit of a signal generator are often sine waves. Most AC power sources produce sine waves. (AC stands for alternating current, although the voltage alternates too. DC stands for direct current, which means a steady current and voltage, such as a battery produces.)

The *damped sine wave* is a special case you may see in a circuit that oscillates but winds down over time.

Figure 14 shows examples of sine and damped sine waves.



Figure 14: Sine and Damped Sine Waves

Square and Rectangular Waves

The *square wave* is another common wave shape. Basically, a square wave is a voltage that turns on and off (or goes high and low) at regular intervals. It is a standard wave for testing amplifiers — good amplifiers increase the amplitude of a square wave with minimum distortion. Television, radio, and computer circuitry often use square waves for timing signals.

The *rectangular wave* is like the square wave except that the high and low time intervals are not of equal length. It is particularly important when analyzing digital circuitry.

Figure 15 shows examples of square and rectangular waves.



Figure 15: Square and Rectangular Waves

Sawtooth and Triangle Waves

Sawtooth and *Triangle* waves result from circuits designed to control voltages linearly, such as the horizontal sweep of an analog oscilloscope or the raster scan of a television. The transitions between voltage levels of these waves change at a constant rate. These transitions are called *ramps*.

Figure 16 shows examples of sawtooth and triangle waves.

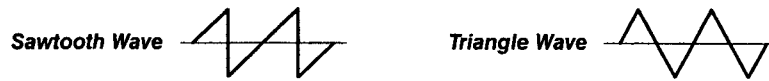

Figure 16: Sawtooth and Rectangular Waves

Step and Pulse Shapes

Signals such as *steps* and *pulses* that only occur once are called *single-shot* or *transient* signals. The step indicates a sudden change in voltage, like what you would see if you turned on a power switch. The pulse indicates what you would see if you turned a power switch on and then off again. It might represent one bit of information traveling through a computer circuit or it might be a *glitch* (a defect) in a circuit.

A collection of pulses travelling together creates a *pulse train*. Digital components in a computer communicate with each other using pulses. Pulses are also common in x-ray and communications equipment.

Figure 17 shows examples of step and pulse shapes and a pulse train.



Figure 17: Step, Pulse, and Pulse Train Shapes

Waveform Measurements

You use many terms to describe the types of measurements that you take with your oscilloscope. This section describes some of the most common measurements and terms.

Frequency and Period

If a signal repeats, it has a *frequency*. The frequency is measured in Hertz (Hz) and equals the number of times the signal repeats itself in one second (the cycles per second). A repeating signal also has a *period* — this is the amount of time it takes the signal to complete one cycle. Period and frequency are reciprocals of each other, so that $1/\text{period}$ equals the frequency and $1/\text{frequency}$ equals the period. So, for example, the sine wave in Figure 18 has a frequency of 3 Hz and a period of $1/3$ second.

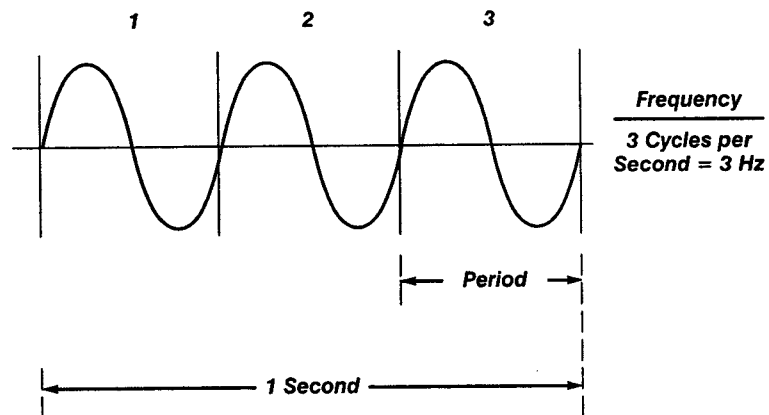

Figure 18: Frequency and Period

Voltage

Voltage is the amount of electric potential (a kind of signal strength) between two points in a circuit. Usually one of these points is ground (zero volts) but not always — you may want to measure the voltage from the maximum peak to the minimum peak of a waveform, referred to as the peak-to-peak voltage. The word amplitude commonly refers to the maximum voltage of a signal measured from ground or zero volts. The waveform shown in Figure 19 has an amplitude of one volt and a peak-to-peak voltage of two volts.

Phase

Phase is best explained by looking at a sine wave. Sine waves are based on circular motion and a circle has 360° . One cycle of a sine wave has 360° , as shown in Figure 19. Using degrees, you can refer to the phase angle of a sine wave when you want to describe how much of the period has elapsed.

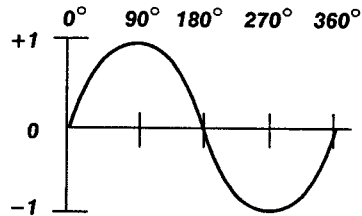

Figure 19: Sine Wave Degrees

Phase shift describes the difference in timing between two otherwise similar signals. In Figure 20, the waveform labeled “current” is said to be 90° out of phase with the waveform labeled “voltage,” since the waves reach similar points in their cycles exactly $1/4$ of a cycle apart ($360^\circ/4 = 90^\circ$). Phase shifts are common in electronics.

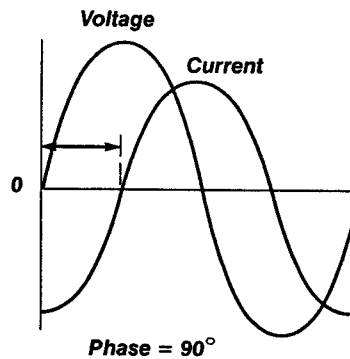

Figure 20: Phase Shift

Performance Terms

The terms described in this section may come up in your discussions about oscilloscope performance. Understanding these terms will help you evaluate and compare your oscilloscope with other models.

Bandwidth

The bandwidth specification tells you the frequency range the oscilloscope accurately measures.

As signal frequency increases, the capability of the oscilloscope to accurately respond decreases. By convention, the bandwidth tells you the frequency at which the displayed signal reduces to 70.7% of the applied sine wave signal. (This 70.7% point is referred to as the “–3 dB point,” a term based on a logarithmic scale.)

Rise Time

Rise time is another way of describing the useful frequency range of an oscilloscope. Rise time may be a more appropriate performance consideration when you expect to measure pulses and steps. An oscilloscope cannot accurately display pulses with rise times faster than the specified rise time of the oscilloscope.

Vertical Sensitivity

The vertical sensitivity indicates how much the vertical amplifier can amplify a weak signal. Vertical sensitivity is usually given in millivolts (mV) per division. The smallest voltage a general purpose oscilloscope can detect is typically about 2 mV per vertical screen division.

Sweep Speed

For analog oscilloscopes, this specification indicates how fast the trace can sweep across the screen, allowing you to see fine details. The fastest sweep speed of an oscilloscope is usually given in nanoseconds/div.

Gain Accuracy

The gain accuracy indicates how accurately the vertical system attenuates or amplifies a signal. This is usually listed as a percentage error.

Time Base or Horizontal Accuracy

The time base or horizontal accuracy indicates how accurately the horizontal system displays the timing of a signal. This is usually listed as a percentage error.

Sample Rate

On digital oscilloscopes, the sampling rate indicates how many samples per second the ADC (and therefore the oscilloscope) can acquire. Maximum sample rates are usually given in megasamples per second (MS/s). The faster the oscilloscope can sample, the more accurately it can represent fine details in a fast signal. The minimum sample rate may also be important if you need to look at slowly changing signals over long periods of time. Typically, the sample rate changes with changes made to the sec/div control to maintain a constant number of waveform points in the waveform record.

ADC Resolution (Or Vertical Resolution)

The resolution, in bits, of the ADC (and therefore the digital oscilloscope) indicates how precisely it can turn input voltages into digital values. Calculation techniques can improve the effective resolution.

Record Length

The record length of a digital oscilloscope indicates how many waveform points the oscilloscope is able to acquire for one waveform record. Some digital oscilloscopes let you adjust the record length. The maximum record length depends on the amount of memory in your oscilloscope. Since the oscilloscope can only store a finite number of waveform points, there is a trade-off between record detail and record length. You can acquire either a detailed picture of a signal for a short period of time (the oscilloscope “fills up” on waveform points quickly) or a less detailed picture for a longer period of time. Some oscilloscopes let you add more memory to increase the record length for special applications.

Setting Up

This section briefly describes how to set up and start using an oscilloscope — specifically, how to ground the oscilloscope, set the controls in standard positions, and compensate the probe.

Grounding

Proper grounding is an important step when setting up to take measurements or work on a circuit. Properly grounding the oscilloscope protects you from a hazardous shock and grounding yourself protects your circuits from damage.

Ground the Oscilloscope

Grounding the oscilloscope is necessary for safety. If a high voltage contacts the case of an ungrounded oscilloscope, any part of the case, including knobs that appear insulated, it can give you a shock. However, with a properly grounded oscilloscope, the current travels through the grounding path to earth ground rather than through *you* to earth ground.

To ground the oscilloscope means to connect it to an electrically neutral reference point (such as earth ground). Ground your oscilloscope by plugging its three-pronged power cord into an outlet grounded to earth ground.

Grounding is also necessary for taking accurate measurements with your oscilloscope. The oscilloscope needs to share the same ground as any circuits you are testing.

Some oscilloscopes do not require the separate connection to earth ground. These oscilloscopes have insulated cases and controls, which keeps any possible shock hazard away from the user.

Ground Yourself

If you are working with integrated circuits (ICs), you also need to ground yourself. Integrated circuits have tiny conduction paths that can be damaged by static electricity that builds up on your body. You can ruin an expensive IC simply by walking across a carpet or taking off a sweater and then touching the leads of the IC. To solve this problem, wear a grounding strap (see Figure 21). This strap safely sends static charges on your body to earth ground.

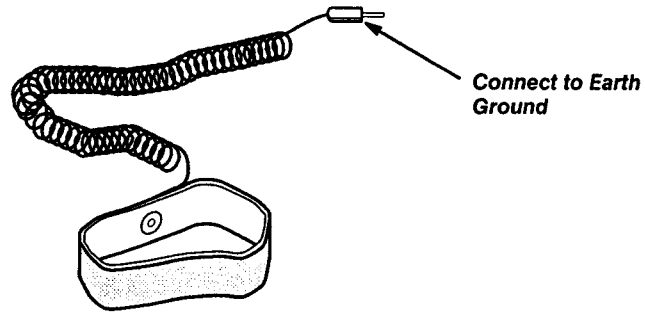

Figure 21: Typical Wrist Type Grounding Strap

Setting the Controls

After plugging in the oscilloscope, take a look at the front panel. It is divided into three main sections labeled *Vertical*, *Horizontal*, and *Trigger*. Your oscilloscope may have other sections, depending on the model and type (analog or digital).

Notice the input connectors on your oscilloscope. This is where you attach probes. Most oscilloscopes have at least two input channels and each channel can display a waveform on the screen. Multiple channels are handy for comparing waveforms.

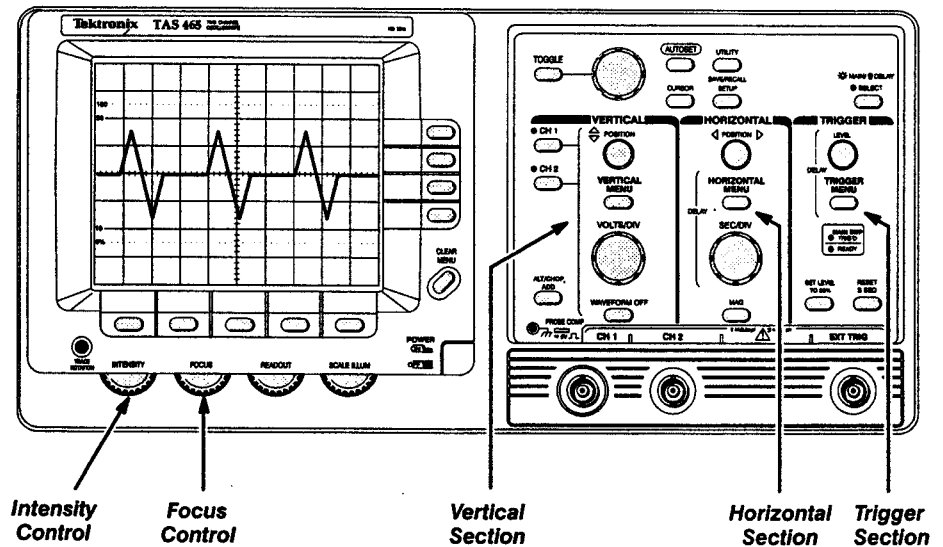

Figure 22: Front Panel Control Sections of an Oscilloscope

Some oscilloscopes have an AUTOSET or PRESET button that sets up the controls in one step to accommodate a signal. If your oscilloscope does not have this feature, it is helpful to set the controls to standard positions before taking measurements.

Standard positions include the following:

- Set the oscilloscope to display channel 1
- Set the volts/division scale to a mid-range position
- Turn off the variable volts/division
- Turn off all magnification settings
- Set the channel 1 input coupling to DC
- Set the trigger mode to auto
- Set the trigger source to channel 1
- Turn trigger holdoff to minimum or off
- Set the intensity control to a nominal viewing level
- Adjust the focus control for a sharp display

These are general instructions for setting up your oscilloscope. If you are not sure how to do any of these steps, refer to the manual that came with your oscilloscope. The *Controls* section beginning on page 29 describes the controls in more detail.

Probes

Now you are ready to connect a probe to your oscilloscope. It is important to use a probe designed to work with your oscilloscope. A probe is more than a cable with a clip-on tip. It is a high-quality connector, carefully designed not to pick up stray radio and power line noise.

Probes are designed not to influence the behavior of the circuit you are testing. However, no measurement device can act as a perfectly invisible observer. The unintentional interaction of the probe and oscilloscope with the circuit being tested is called *circuit loading*. To minimize circuit loading, you will probably use a 10X attenuator (passive) probe.

Your oscilloscope probably arrived with a passive probe as a standard accessory. Passive probes provide you with an excellent tool for general-purpose testing and troubleshooting. For more specific measurements or tests, many other types of probes exist. Two examples are active and current probes.

Descriptions of these probes follow, with more emphasis given to the passive probe since this is the probe type that allows you the most flexibility of use.

Using Passive Probes

Most passive probes have some degree of attenuation factor, such as 10X, 100X, and so on. By convention, attenuation factors, such as for the 10X attenuator probe, have the X after the factor. In contrast, magnification factors like X10 have the X first.

The 10X (read as “ten times”) attenuator probe minimizes circuit loading and is an excellent general-purpose passive probe. Circuit loading becomes more pronounced at higher frequencies, so be sure to use this type of probe when measuring signals above 5 kHz. The 10X attenuator probe improves the accuracy of your measurements, but it also reduces the amplitude of the signal seen on the screen by a factor of 10.

Because it attenuates the signal, the 10X attenuator probe makes it difficult to look at signals less than 10 millivolts. The 1X probe is similar to the 10X attenuator probe but lacks the attenuation circuitry. Without this circuitry, more interference is introduced to the circuit being tested. Use the 10X attenuator probe as your standard probe, but keep the 1X probe handy for measuring weak signals. Some probes have a convenient feature for switching between 1X and 10X attenuation at the probe tip. If your probe has this feature, make sure you are using the correct setting before taking measurements.

Many oscilloscopes can detect whether you are using a 1X or 10X probe and adjust their screen readouts accordingly. However with some oscilloscopes, you must set the type of probe you are using or read from the proper 1X or 10X marking on the volts/div control.

The 10X attenuator probe works by balancing the probe's electrical properties against the oscilloscope's electrical properties. Before using a 10X attenuator probe you need to adjust this balance for your particular oscilloscope. This adjustment is called compensating the probe and is further described on page 26. Figure 23 shows a simple diagram of the internal workings of a probe, its adjustment, and the input of an oscilloscope.

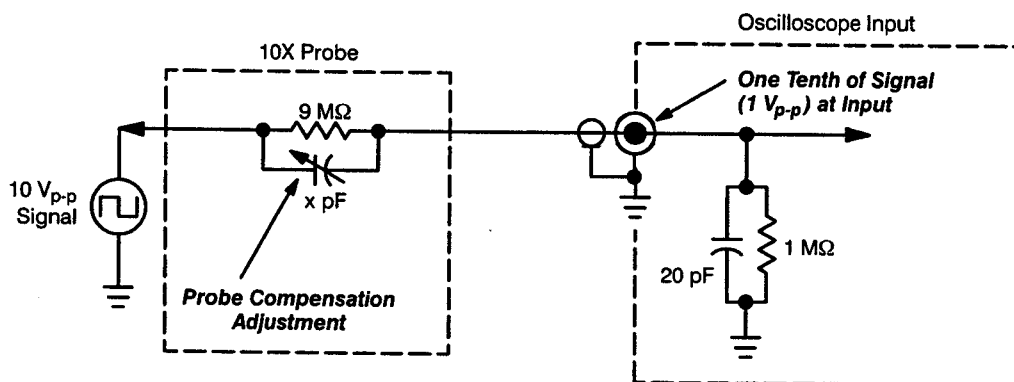

Figure 23: Typical Probe/Oscilloscope 10-to-1 Divider Network

Figure 24 shows a typical passive probe and some accessories to use with the probe.

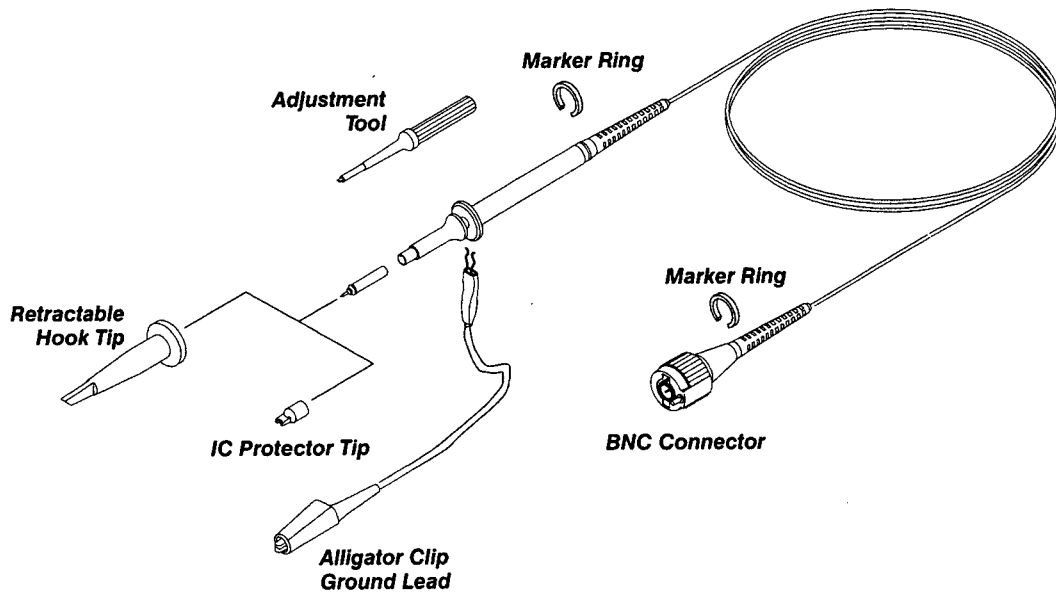

Figure 24: A Typical Passive Probe with Accessories

Using Active Probes

Active probes provide their own amplification or perform some other type of operation to process the signal before applying it to the oscilloscope. These types of probes can solve problems such as circuit loading or perform tests on signals, sending the results to the oscilloscope. Active probes require a power source for their operation.

Using Current Probes

Current probes enable you to directly observe and measure current waveforms. They are available for measuring both AC and DC current. Current probes use jaws that clip around the wire carrying the current. This makes them unique since they are not connected in series with the circuit; they, therefore, cause little or no interference in the circuit.

Where to Clip the Ground Clip

Measuring a signal requires two connections: the probe tip connection and a ground connection. Probes come with an alligator-clip attachment for grounding the probe to the circuit under test. In practice, you clip the grounding clip to a known ground in the circuit, such as the metal chassis of a stereo you are repairing, and touch the probe tip to a test point in the circuit.

Compensating the Probe

Before using a passive probe, you need to compensate it — to balance its electrical properties to a particular oscilloscope. You should get into the habit of compensating the probe every time you set up your oscilloscope. A poorly adjusted probe can make your measurements less accurate. Figure 25 shows what happens to measured waveforms when using a probe not properly compensated.

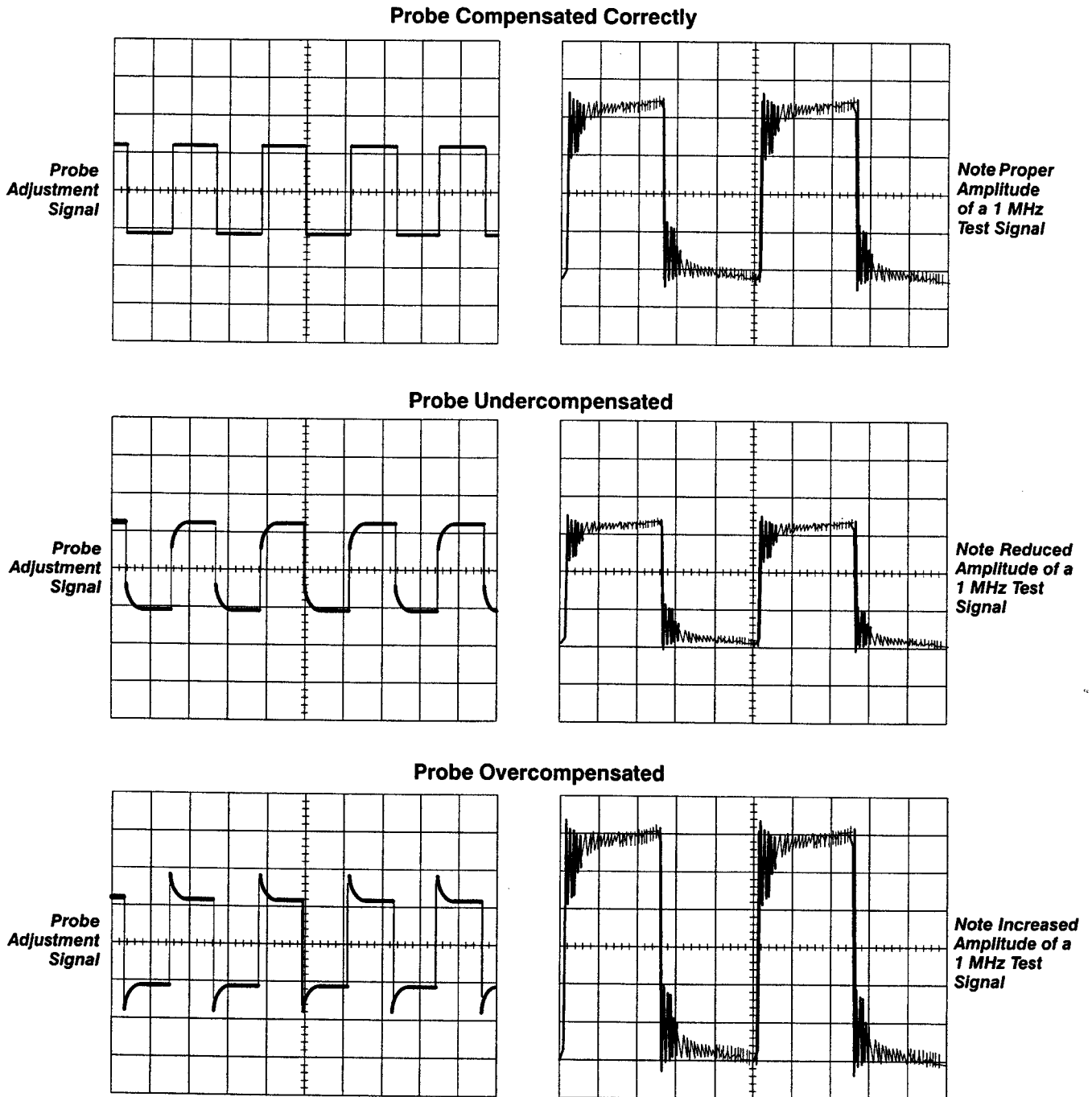

Figure 25: The Effects of Improper Probe Compensation

Most oscilloscopes have a square wave reference signal available at a terminal on the front panel used to compensate the probe. You compensate a probe by:

- Attaching the probe to an input connector
- Connecting the probe tip to the probe compensation signal
- Attaching the ground clip of the probe to ground
- Viewing the square wave reference signal
- Making the proper adjustments on the probe so that the corners of the square wave are square

When you compensate the probe, always attach any accessory tips you will use and connect the probe to the vertical channel you plan to use. This way the oscilloscope has the same electrical properties as it does when you take measurements.

The Controls

This section briefly describes the basic controls found on analog and digital oscilloscopes. Remember that some controls differ between analog and digital oscilloscopes; your oscilloscope probably has controls not discussed here.

Display Controls

Display systems vary between analog and digital oscilloscopes. Common controls include:

- An intensity control to adjust the brightness of the waveform. As you increase the sweep speed of an analog oscilloscope, you need to increase the intensity level.
- A focus control to adjust the sharpness of the waveform. Digital oscilloscopes may not have a focus control.
- A trace rotation control to align the waveform trace with the screen's horizontal axis. The position of your oscilloscope in the earth's magnetic field affects waveform alignment. Digital oscilloscopes may not have a trace rotation control.
- Other display controls may let you adjust the intensity of the graticule lights and turn on or off any on-screen information (such as menus).

Vertical Controls

Use the vertical controls to position and scale the waveform vertically. Your oscilloscope also has controls for setting the input coupling and other signal conditioning, described in this section. Figure 26 shows a typical front panel and on-screen menus for the vertical controls.

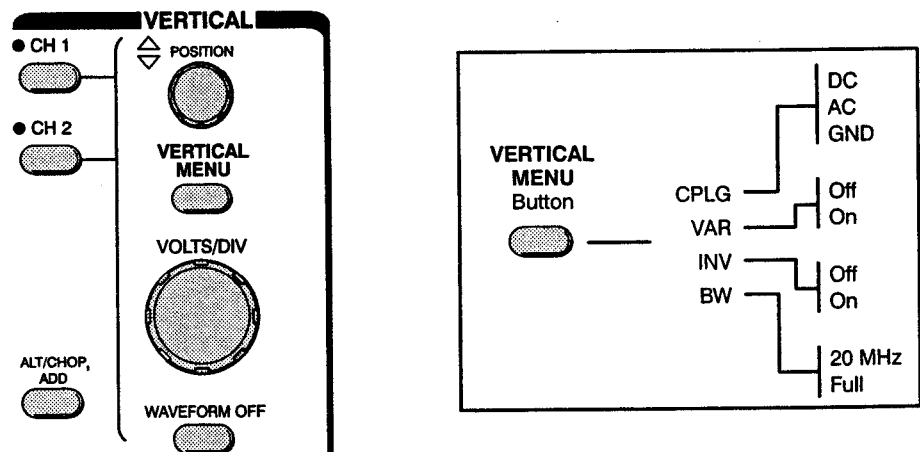

Figure 26: Vertical Controls

Position and Volts per Division

The vertical position control lets you move the waveform up or down to exactly where you want it on the screen.

The volts per division (usually written volts/div) setting varies the size of the waveform on the screen. A good general purpose oscilloscope can accurately display signal levels from about 4 millivolts to 40 volts.

The volts/div setting is a scale factor. For example, if the volts/div setting is 5 volts, then each of the eight vertical divisions represents 5 volts and the entire screen can show 40 volts from bottom to top (assuming a graticule with eight major divisions). If the setting is 0.5 volts/div, the screen can display 4 volts from bottom to top, and so on. The maximum voltage you can display on the screen is the volts/div setting times the number of vertical divisions. (Recall that the probe you use, 1X or 10X, also influences the scale factor. You must divide the volts/div scale by the attenuation factor of the probe if the oscilloscope does not do it for you.)

Often the volts/div scale has either a variable gain or a fine gain control for scaling a displayed signal to a certain number of divisions. Use this control to take rise time measurements.

Input Coupling

Coupling means the method used to connect an electrical signal from one circuit to another. In this case, the input coupling is the connection from your test circuit to the oscilloscope. The coupling can be set to DC, AC, or ground. DC coupling shows all of an input signal. AC coupling blocks the DC component of a signal so that you see the waveform centered at zero volts. Figure 27 illustrates this difference. The AC coupling setting is handy when the entire signal (alternating plus constant components) is too large for the volts/div setting.

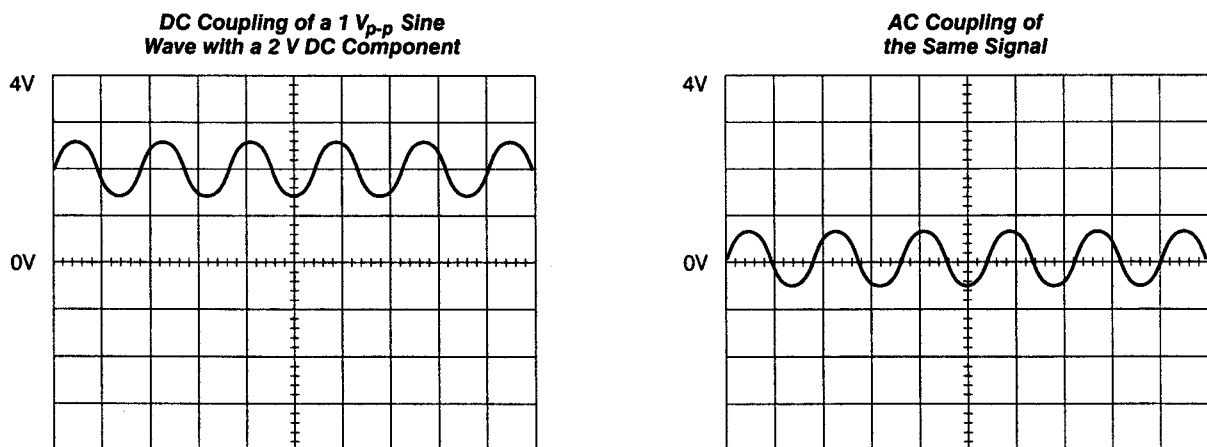

Figure 27: AC and DC Input Coupling

The ground setting disconnects the input signal from the vertical system, which lets you see where zero volts is on the screen. With grounded input coupling and auto trigger mode, you see a horizontal line on the screen that represents zero volts. Switching from DC to ground and back again is a handy way of measuring signal voltage levels with respect to ground.

Bandwidth Limit

Most oscilloscopes have a circuit that limits the bandwidth of the oscilloscope. By limiting the bandwidth, you reduce the noise that sometimes appears on the displayed waveform, providing you with a more defined signal display.

Channel Invert

Most oscilloscopes have an invert function that allows you to display a signal “upside-down.” That is, with low voltage at the top of the screen and high voltage at the bottom.

Alternate and Chop Display

On analog scopes, multiple channels are displayed using either an alternate or chop mode. (Digital oscilloscopes do not normally use chop or alternate mode.)

Alternate mode draws each channel alternately — the oscilloscope completes one sweep on channel 1, then one sweep on channel 2, a second sweep on channel 1, and so on. Use this mode with medium- to high-speed signals, when the sec/div scale is set to 0.5 ms or faster.

Chop mode causes the oscilloscope to draw small parts of each signal by switching back and forth between them. The switching rate is too fast for you to notice, so the waveform looks whole. You typically use this mode with slow signals requiring sweep speeds of 1 ms per division or less. Figure 28 shows the difference between the two modes. It is often useful to view the signal both ways, to make sure you have the best view.

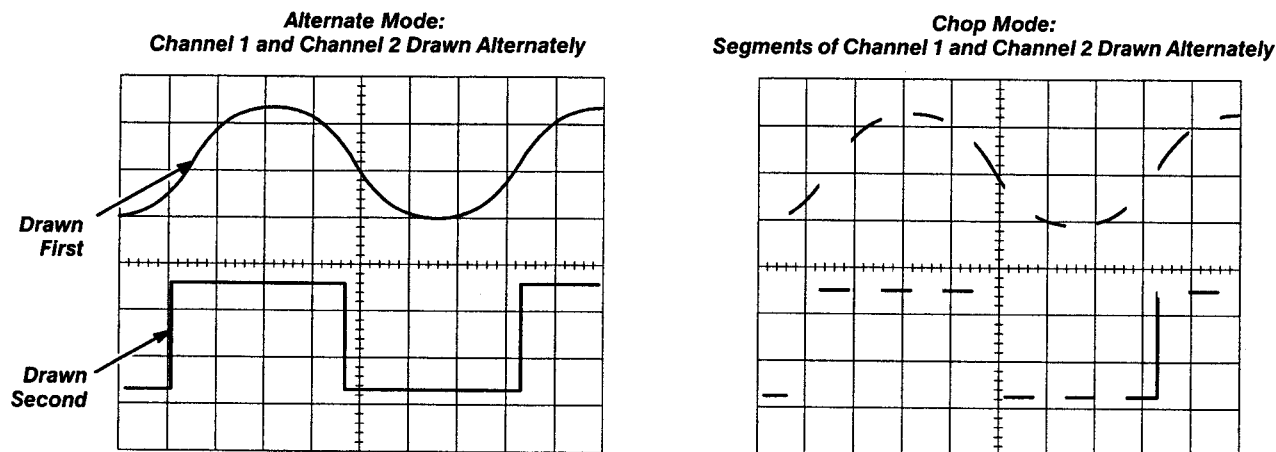

Figure 28: Multi-Channel Display Modes

Math Operations

Your oscilloscope may also have operations to allow you to add waveforms together, creating a new waveform display. Analog oscilloscopes combine the signals while digital oscilloscopes mathematically create new waveforms. Subtracting waveforms is another math operation. Subtraction with analog oscilloscopes is possible by using the channel invert function on one signal and then use the add operation. Digital oscilloscopes typically have a subtraction operation available. Figure 29 illustrates a third waveform created by adding two different signals together.

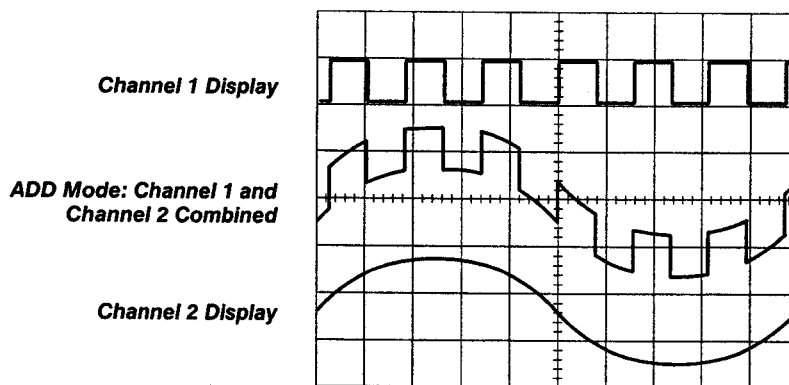

Figure 29: Adding Channels

Horizontal Controls

Use the horizontal controls to position and scale the waveform horizontally. Figure 30 shows a typical front panel and on-screen menus for the horizontal controls.

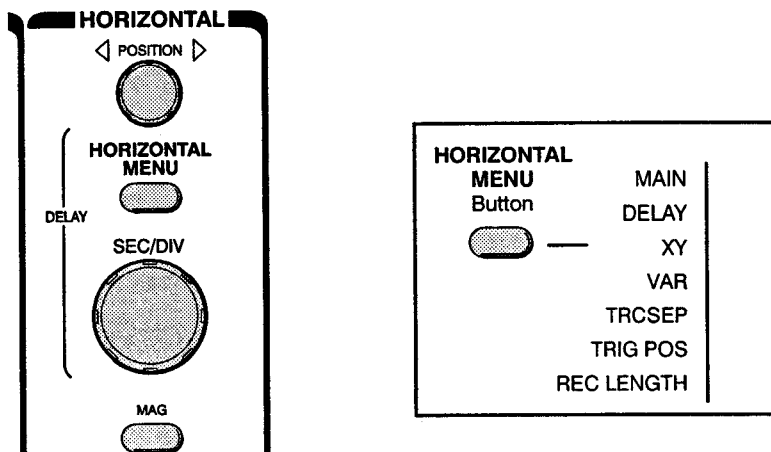

Figure 30: Horizontal Controls

Position and Seconds per Division

The horizontal position control moves the waveform from left and right to exactly where you want it on the screen.

The seconds per division (usually written as sec/div) setting lets you select the rate at which the waveform is drawn across the screen (also known as the time base setting or sweep speed). This setting is a scale factor. For example, if the setting is 1 ms, each horizontal division represents 1 ms and the total screen width represents 10 ms (ten divisions). Changing the sec/div setting lets you look at longer or shorter time intervals of the input signal.

As with the vertical volts/div scale, the horizontal sec/div scale may have variable timing, allowing you to set the horizontal time scale in between the discrete settings.

Time Base Selections

Your oscilloscope has a time base usually referred to as the main time base and it is probably the most useful. Many oscilloscopes have what is called a delayed time base — a time base sweep that starts after a pre-determined time from the start of the main time base sweep. Using a delayed time base sweep allows you to see events more clearly or even see events not visible with just the main time base sweep.

The delayed time base requires the setting of a delay time and possibly the use of delayed trigger modes and other settings not described in this book. Refer to the manual supplied with your oscilloscope for information on how to use these features.

Trigger Position

The trigger position control may be located in the horizontal control section of your oscilloscope. It actually represents “the *horizontal* position of the trigger in the waveform record.” Horizontal trigger position control is only available on digital oscilloscopes.

Varying the horizontal trigger position allows you to capture what a signal did *before* a trigger event (called *pretrigger viewing*).

Digital oscilloscopes can provide pretrigger viewing because they constantly process the input signal whether a trigger has been received or not. A steady stream of data flows through the oscilloscope; the trigger merely tells the oscilloscope to save the present data in memory. In contrast, analog oscilloscopes only display the signal after receiving the trigger.

Pretrigger viewing is a valuable troubleshooting aid. For example, if a problem occurs intermittently, you can trigger on the problem, record the events that led up to it and, possibly, find the cause.

Magnification

Your oscilloscope may have special horizontal magnification settings that let you display a magnified section of the waveform on-screen.

XY Mode

Most oscilloscopes have the capability of displaying a second channel signal along the X-axis (instead of time). This is called XY mode; you will find a longer discussion on page 47.

Trigger Controls

The trigger controls let you stabilize repeating waveforms and capture single-shot waveforms. Figure 31 shows a typical front panel and on-screen menu for the trigger controls.

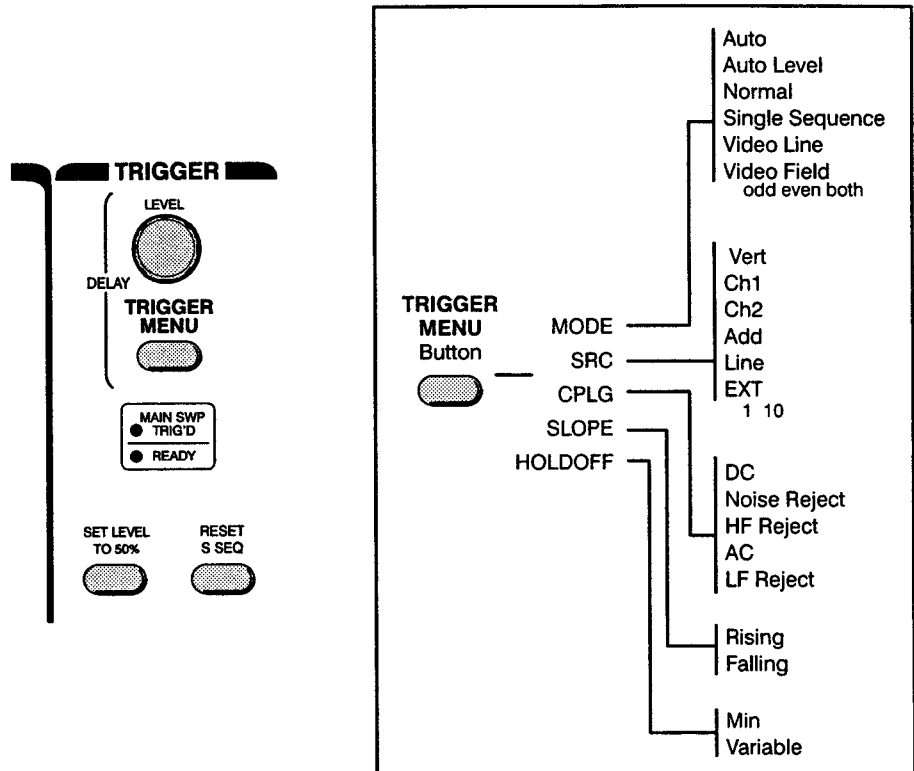

Figure 31: Trigger Controls

The trigger makes repeating waveforms appear static on the oscilloscope display. Imagine the jumble on the screen that would result if each sweep started at a different place on the signal (see Figure 32).

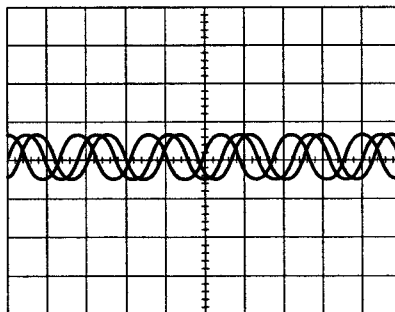

Figure 32: Untriggered Display

Trigger Level and Slope

Your oscilloscope may have several different types of triggers, such as edge, video, pulse, or logic. Edge triggering is the basic and most common type and is the only type discussed in this book. Consult your oscilloscope instruction manual for details on other trigger types.

For edge triggering, the trigger level and slope controls provide the basic trigger point definition.

The trigger circuit acts as a comparator. You select the slope and voltage level of one side of the comparator. When the trigger signal matches your settings, the oscilloscope generates a trigger.

- The slope control determines whether the trigger point is on the rising or the falling edge of a signal. A rising edge is a positive slope and a falling edge is a negative slope.
- The level control determines where on the edge the trigger point occurs.

Figure 33 shows you how the trigger slope and level settings determine how a waveform is displayed.

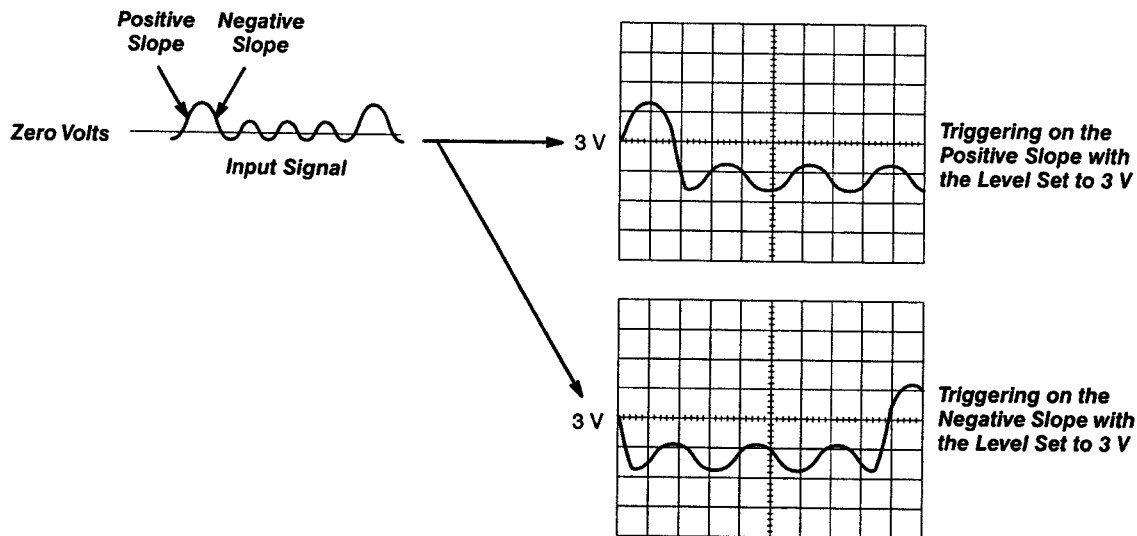

Figure 33: Positive and Negative Slope Triggering

Trigger Sources

The oscilloscope does not necessarily have to trigger on the signal being measured. Several sources can trigger the sweep:

- Any input channel
- An external source, other than the signal applied to an input channel
- The power source signal
- A signal internally generated by the oscilloscope

Most of the time you can leave the oscilloscope set to trigger on the channel displayed.

Note that the oscilloscope can use an alternate trigger source whether displayed or not. So you have to be careful not to unwittingly trigger on, for example, channel 1 while displaying channel 2.

Trigger Modes

The trigger mode determines whether or not the oscilloscope draws a waveform if it does not detect a trigger. Common trigger modes include *normal* and *auto*.

In normal mode the oscilloscope only sweeps if the input signal reaches the set trigger point; otherwise (on an analog oscilloscope) the screen is blank or (on a digital oscilloscope) frozen on the last acquired waveform. Normal mode can be disorienting since you may not see the signal at first if the level control is not adjusted correctly.

Auto mode causes the oscilloscope to sweep, even without a trigger. If no signal is present, a timer in the oscilloscope triggers the sweep. This ensures that the display will not disappear if the signal drops to small voltages. It is also the best mode to use if you are looking at many signals and do not want to bother setting the trigger each time.

In practice, you will probably use both modes: normal mode because it is more versatile and auto mode because it requires less adjustment.

Some oscilloscopes also include special modes for single sweeps, triggering on video signals, or automatically setting the trigger level.

Trigger Coupling

Just as you can select either AC or DC coupling for the vertical system, you can choose the kind of coupling for the trigger signal.

Besides AC and DC coupling, your oscilloscope may also have high frequency rejection, low frequency rejection, and noise rejection trigger coupling. These special settings are useful for eliminating noise from the trigger signal to prevent false triggering.

Trigger Holdoff

Sometimes getting an oscilloscope to trigger on the correct part of a signal requires great skill. Many oscilloscopes have special features to make this task easier.

Trigger *holdoff* is an adjustable period of time during which the oscilloscope cannot trigger. This feature is useful when you are triggering on complex waveform shapes, so that the oscilloscope only triggers on the first eligible trigger point. Figure 34 shows how using trigger holdoff helps create a usable display.

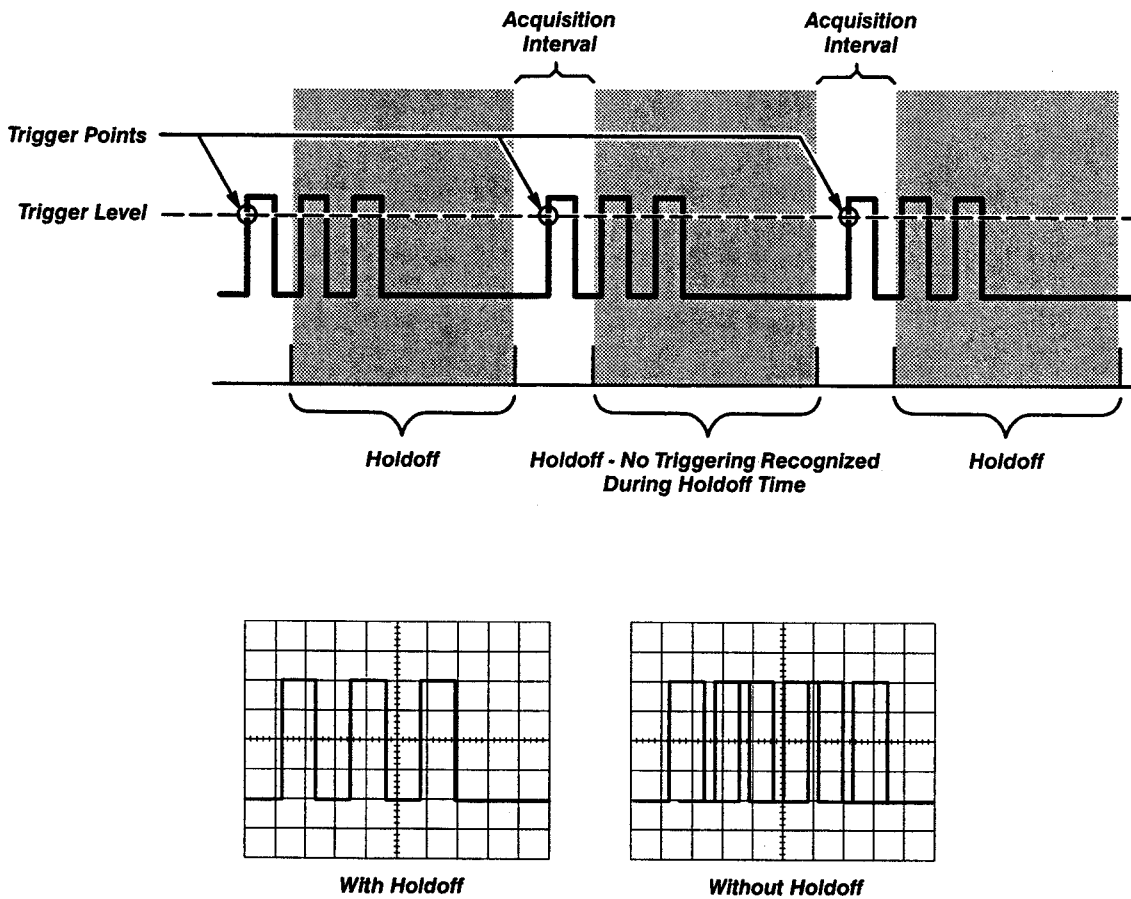

Figure 34: Trigger Holdoff

Acquisition Controls for Digital Oscilloscopes

Digital oscilloscopes have settings that let you control how the acquisition system processes a signal. Look over the acquisition options on your digital oscilloscope while you read this description. Figure 35 shows you an example of an acquisition menu.

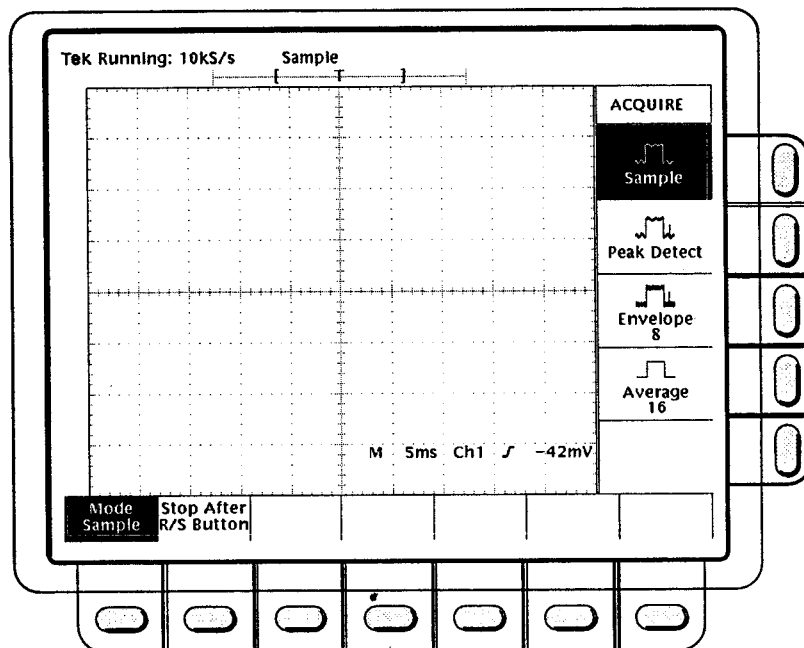

Figure 35: Example of an Acquisition Menu

Acquisition Modes

Acquisition modes control how waveform points are produced from sample points. Recall from the first section that sample points are the digital values that come directly out of the Analog-to-Digital-Converter (ADC). The time between sample points is called the sample interval. Waveform points are the digital values that are stored in memory and displayed to form the waveform. The time value difference between waveform points is called the waveform interval. The sample interval and the waveform interval may be but need not be the same. This fact leads to the existence of several different acquisition modes in which one waveform point is made up from several sequentially acquired sample points. Additionally, waveform points can be created from a composite of sample points taken from multiple acquisitions, which leads to another set of acquisition modes. A description of the most commonly used acquisition modes follows.

- Sample Mode:** This is the simplest acquisition mode. The oscilloscope creates a waveform point by saving one sample point during each waveform interval.

- **Peak Detect Mode:** The oscilloscope saves the minimum and maximum value sample points taken during two waveform intervals and uses these samples as the two corresponding waveform points. Digital oscilloscopes with peak detect mode run the ADC at a fast sample rate, even at very slow time base settings (long waveform interval), and are able to capture fast signal changes that would occur between the waveform points if in sample mode. Peak detect mode is particularly useful for seeing narrow pulses spaced far apart in time.
- **Hi Res Mode:** Like peak detect, hi res mode is a way of getting more information in cases when the ADC can sample faster than the time base setting requires. In this case, multiple samples taken within one waveform interval are averaged together to produce one waveform point. The result is a decrease in noise and an improvement in resolution for low speed signals.
- **Envelope Mode:** Envelope mode is similar to peak detect mode. However, in envelope mode, the minimum and maximum waveform points from multiple acquisitions are combined to form a waveform that shows min/max changes over time. Peak detect mode is usually used to acquire the records that are combined to form the envelope waveform.
- **Average Mode:** In average mode, the oscilloscope saves one sample point during each waveform interval as in sample mode. However, waveform points from consecutive acquisitions are then averaged together to produce the final displayed waveform. Average mode reduces noise without loss of bandwidth but requires a repeating signal.

Stopping and Starting the Acquisition System

One of the greatest advantages of digital oscilloscopes is their ability to store waveforms for later viewing. To this end, there are usually one or more buttons on the front panel that allow you to stop and start the acquisition system so you can analyze waveforms at your leisure. Additionally, you may want the oscilloscope to automatically stop acquiring after one acquisition is complete or after one set of records has been turned into an envelope or average waveform. This feature is commonly called single sweep or single sequence and its controls are usually found either with the other acquisition controls or with the trigger controls.

Sampling Methods

In digital oscilloscopes that can use either real-time sampling or equivalent-time sampling as described on page 10, the acquisition controls will allow you to choose which one to use for acquiring signals. Note that this choice makes no difference for slow time base settings and only has an effect when the ADC cannot sample fast enough to fill the record with waveform points in one pass.

Other Controls

So far we have described the basic controls that a beginner needs to know about. Your oscilloscope may have other controls for various functions. Some of these may include:

- Measurement cursors
- Keypads for mathematical operations or data entry
- Print capabilities
- Interfaces for connecting your oscilloscope to a computer

Look over the other options available to you and read your oscilloscope's manual to find out more about these other controls.

Measurement Techniques

This section teaches you basic measurement techniques. The two most basic measurements you can make are voltage and time measurements. Just about every other measurement is based on one of these two fundamental techniques.

This section discusses methods for taking measurements visually with the oscilloscope screen. Many digital oscilloscopes have internal software that will take these measurements automatically. Knowing how to take the measurements manually will help you understand and check the automatic measurements of the digital oscilloscopes.

The Display

Take a look at the oscilloscope display. Notice the grid markings on the screen — these markings create the *graticule*. Each vertical and horizontal line constitutes a *major division*. The graticule is usually laid out in an 8-by-10 division pattern. Labeling on the oscilloscope controls (such as volts/div and sec/div) always refers to major divisions. The tick marks on the center horizontal and vertical graticule lines (see Figure 36) are called minor divisions.

Many oscilloscopes display on the screen how many volts each vertical division represents and how many seconds each horizontal division represents. Many oscilloscopes also have 0%, 10%, 90%, and 100% markings on the graticule (see Figure 36) to help make rise time measurements, described on page 46.

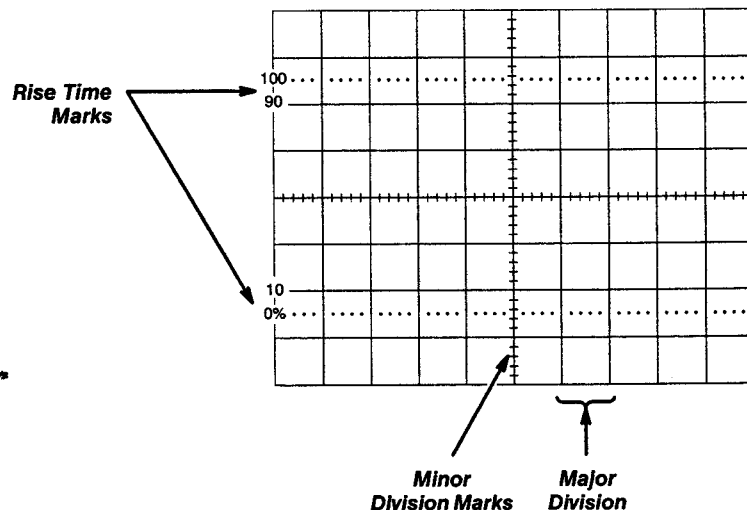

Figure 36: An Oscilloscope Graticule

Voltage Measurements

Voltage is the amount of electric potential, expressed in volts, between two points in a circuit. Usually one of these points is ground (zero volts) but not always. Voltages can also be measured from peak-to-peak — from the maximum point of a signal to its minimum point. You must be careful to specify which voltage you mean.

The oscilloscope is primarily a voltage-measuring device. Once you have measured the voltage, other quantities are just a calculation away. For example, Ohm's law states that voltage between two points in a circuit equals the current times the resistance. From any two of these quantities you can calculate the third. Another handy formula is the power law: the power of a DC signal equals the voltage times the current. Calculations are more complicated for AC signals, but the point here is that measuring the voltage is the first step towards calculating other quantities.

Ohm's Law:

$$\text{Voltage} = \text{Current} \times \text{Resistance}$$

$$\text{Current} = \frac{\text{Voltage}}{\text{Resistance}}$$

$$\text{Resistance} = \frac{\text{Voltage}}{\text{Current}}$$

Power Law:

$$\text{Power} = \text{Voltage} \times \text{Current}$$

Figure 37 shows the voltage of one peak (V_p) and the peak-to-peak voltage (V_{p-p}), which is usually twice V_p . Use the RMS (root-mean-square) voltage (V_{RMS}) to calculate the power of an AC signal.

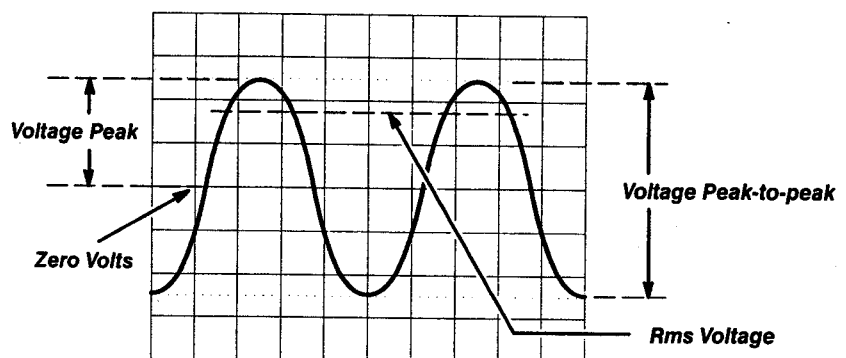

Figure 37: Voltage Peak and Peak-to-peak Voltage

You take voltage measurements by counting the number of divisions a waveform spans on the oscilloscope's vertical scale. Adjusting the signal to cover most of the screen vertically, then taking the measurement along the

center vertical graticule line having the smaller divisions, makes for the best voltage measurements. The more screen area you use, the more accurately you can read from the screen.

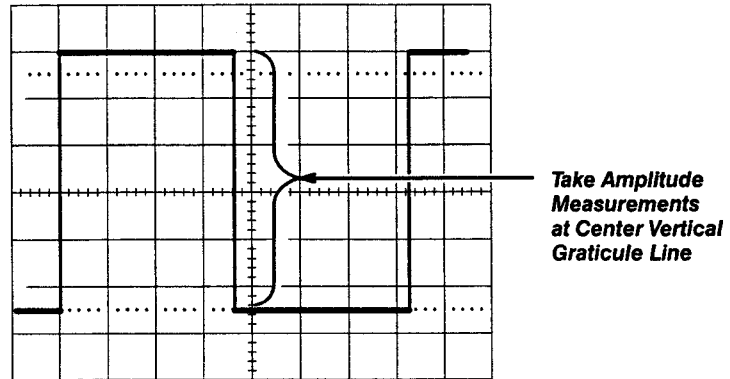
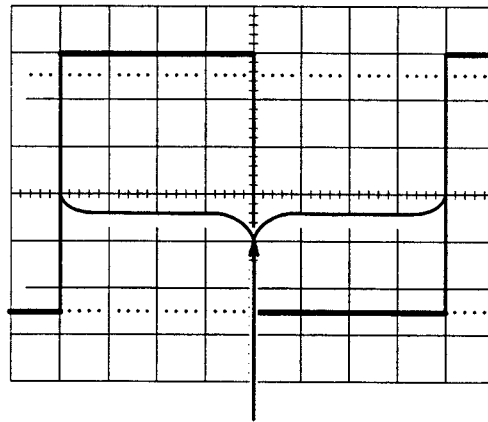

Figure 38: Measure Voltage on the Center Vertical Graticule Line

Many oscilloscopes have on-screen *cursors* that let you take waveform measurements automatically on-screen, without having to count graticule marks. Basically, cursors are two horizontal lines for voltage measurements and two vertical lines for time measurements that you can move around the screen. A readout shows the voltage or time at their positions.

Time and Frequency Measurements

You take time measurements using the horizontal scale of the oscilloscope. Time measurements include measuring the period, pulse width, and timing of pulses. Frequency is the reciprocal of the period, so once you know the period, the frequency is one divided by the period. Like voltage measurements, time measurements are more accurate when you adjust the portion of the signal to be measured to cover a large area of the screen. Taking time measurement along the center horizontal graticule line, having smaller divisions, makes for the best time measurements. (See Figure 39.)



Take Time Measurements
at Center Horizontal Graticule Line

Figure 39: Measure Time on the Center Horizontal Graticule Line

Pulse and Rise Time Measurements

In many applications, the details of a pulse's shape are important. Pulses can become distorted and cause a digital circuit to malfunction, and the timing of pulses in a pulse train is often significant.

Standard pulse measurements are *pulse width* and *pulse rise time*. Rise time is the amount of time a pulse takes to go from the low to high voltage. By convention, the rise time is measured from 10% to 90% of the full voltage of the pulse. This eliminates any irregularities at the pulse's transition corners. This also explains why most oscilloscopes have 10% and 90% markings on their screen. Pulse width is the amount of time the pulse takes to go from low to high and back to low again. By convention, the pulse width is measured at 50% of full voltage. See Figure 40 for these measurement points.

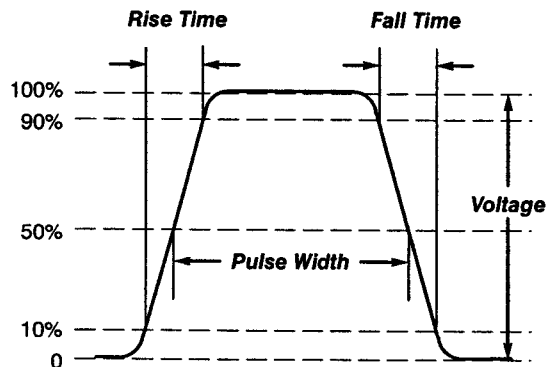

Figure 40: Rise Time and Pulse Width Measurement Points

Pulse measurements often require fine-tuning the triggering. To become an expert at capturing pulses, you should learn how to use trigger holdoff and how to set the digital oscilloscope to capture pretrigger data, as described earlier in the *Controls* section. Horizontal magnification is another useful feature for measuring pulses, since it allows you to see fine details of a fast pulse.

Phase Shift Measurements

The horizontal control section may have an XY mode that lets you display an input signal rather than the time base on the horizontal axis. (On some digital oscilloscopes this is a display mode setting.) This mode of operation opens up a whole new area of phase shift measurement techniques.

The phase of a wave is the amount of time that passes from the beginning of a cycle to the beginning of the next cycle, measured in degrees. Phase shift describes the difference in timing between two otherwise identical periodic signals.

One method for measuring phase shift is to use XY mode. This involves inputting one signal into the vertical system as usual and then another signal into the horizontal system. (This method only works if both signals are sine waves.) This set up is called an XY measurement because both the X and Y axis are tracing voltages. The waveform resulting from this arrangement is called a Lissajous pattern (named for French physicist Jules Antoine Lissajous and pronounced LEE-sa-zhoo). From the shape of the Lissajous pattern, you can tell the phase difference between the two signals. You can also tell their frequency ratio. Figure 41 shows Lissajous patterns for various frequency ratios and phase shifts.

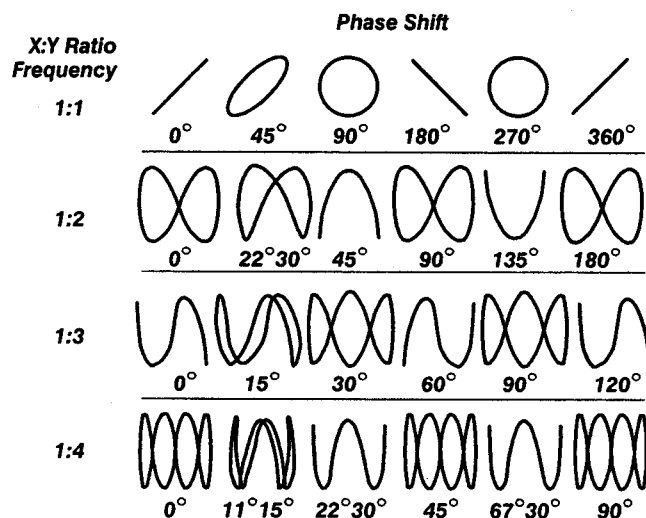

Figure 41: Lissajous Patterns

What's Next?

This section has covered basic measurement techniques. Other measurement techniques involve setting up the oscilloscope to test electrical components on an assembly line, subtracting noise from a signal, capturing elusive transient signals, and many others that would take too much room to list. The measurement techniques you will use depend on your application, but you have learned enough to get started. Practice using your oscilloscope and read more about it. Soon its operation will be second nature to you.

Written Exercises

This section contains written exercises that cover information in this book. The exercises are divided into two parts, Part I and Part II.

Part I covers information presented in these sections:

- *The Oscilloscope*
- *Oscilloscope Terminology*

Part II covers information presented in sections:

- *Setting Up*
- *The Controls*
- *Measurement Techniques*

Part I Exercises

The following exercises cover information presented in these sections:

- *The Oscilloscope*
- *Oscilloscope Terminology*

Check how well you have absorbed the information in these sections by doing this short self-test. Answers begin on page 58.

Vocabulary Exercise

Write the number of the definitions in the right column next to the correct words in the left column.

Term	Definition
1. ___ Acquisition	A The unit of electric potential difference.
2. ___ Analog	B A performance measurement indicating the precision of an ADC, measured in bits.
3. ___ Bandwidth	C Term used when referring to degree points of a sine wave.
4. ___ Digital	D The number of times a signal repeats in one second.
5. ___ Frequency	E The amount of time it takes a wave to complete one cycle.
6. ___ Glitch	F A stored digital value that represents the voltage of a signal at a specific point in time.
7. ___ Period	G A common waveform shape that has a rising edge, a width, and a falling edge.
8. ___ Phase	H A performance measurement indicating the fastest edge a given oscilloscope can accurately display.
9. ___ Pulse	I Oscilloscope circuitry that controls the timing of the sweep.
10. ___ Waveform Point	J An intermittent error in a circuit.
11. ___ Rise Time	K A signal measured by an oscilloscope that only occurs once.
12. ___ Sample Point	L The oscilloscope's process of collecting sample points from the ADC, processing them, and storing them in memory.
13. ___ Time Base	M Something that operates with continuous values.
14. ___ Transient	N Something that operates with discrete values.
15. ___ ADC Resolution	O A frequency range.
16. ___ Volt	P The raw data from an ADC used to calculate waveform points.

Using Oscilloscopes Exercise

Circle the best answers for each statement. Some statements have more than one right answer.

1. With an oscilloscope you can:
 - a. Calculate the frequency of a signal.
 - b. Find malfunctioning electrical components.
 - c. Analyze bird calls.
 - d. All the above.
2. The difference between analog and digital oscilloscopes is:
 - a. Analog oscilloscopes do not have on-screen menus.
 - b. Analog oscilloscopes apply a measurement voltage directly to the display system, while digital oscilloscopes first convert the voltage into digital values.
 - c. Analog oscilloscopes measure analogs, whereas digital oscilloscopes measure digits.
 - d. Analog oscilloscopes do not have an acquisition system.
3. An oscilloscope's vertical section does the following:
 - a. Acquires sample points with an ADC.
 - b. Starts a horizontal sweep.
 - c. Lets you adjust the brightness of the display.
 - d. Attenuates or amplifies the input signal.
4. The time base control of the oscilloscope does the following:
 - a. Adjusts the vertical scale.
 - b. Shows you the current time of day.
 - c. Sets the amount of time represented by the horizontal width of the screen.
 - d. Sends a clock pulse to the probe.
5. On an oscilloscope display:
 - a. Voltage is on the vertical axis and time is on the horizontal axis.
 - b. A straight diagonal trace means voltage is changing at a steady rate.
 - c. A flat horizontal trace means voltage is constant.
 - d. All the above.

6. All repeating waves have the following properties:
 - a. A frequency measured in hertz.
 - b. A period measured in seconds.
 - c. A bandwidth measured in hertz.
 - d. All the above.

7. If you probe inside a computer with an oscilloscope, you are likely to find the following types of signals:
 - a. Pulse trains.
 - b. Ramp waves.
 - c. Sine waves.
 - d. All the above.

8. When evaluating the performance of an analog oscilloscope, some things you might consider are:
 - a. The bandwidth.
 - b. The vertical sensitivity.
 - c. The ADC resolution.
 - d. The sweep speed.

Part II Exercises

The following exercises cover information presented in these sections:

- *Setting Up*
- *The Controls*
- *Measurement Techniques*

Check how well you have absorbed the information in these sections by doing this short self-test. Answers begin on page 58.

Vocabulary Exercise

Write the letter of the definitions in the right column next to the correct words in the left column.

Term	Definition
1. ____ Averaging Mode	A The unintentional interaction of the probe and oscilloscope with the circuit being tested which distorts a signal.
2. ____ Circuit Loading	B A conductor that connects electrical currents to the Earth.
3. ____ Compensation	C A sampling mode in which the digital oscilloscope collects as many samples as it can as the signal occurs, then constructs a display, using interpolation if necessary.
4. ____ Coupling	D A sampling mode in which the digital oscilloscope constructs a picture of a repetitive signal by capturing a little bit of information from each repetition.
5. ____ Earth Ground	E A device that converts a specific physical quantity such as sound, pressure, strain, or light intensity into an electrical signal.
6. ____ Equivalent-Time	F A test device for injecting a signal into a circuit input.
7. ____ Graticule	G A processing technique used by digital oscilloscopes to eliminate noise in a signal.
8. ____ Interpolation	H The method of connecting two circuits together.
9. ____ Real Time	I A "connect-the-dots" processing technique to estimate what a fast waveform looks like based on only a few sampled points.
10. ____ Signal Generator	J The grid lines on a screen for measuring oscilloscope traces.
11. ____ Single Sweep	K A trigger mode that triggers the sweep once, must be reset to accept another trigger event.
12. ____ Transducer	L A probe adjustment for 10X attenuator probes that balances the electrical properties of the probe with the electrical properties of the oscilloscope.

Using Oscilloscopes Exercise

Circle the best answers for each statement. Some statements have more than one right answer.

1. To operate an oscilloscope safely, you should:
 - a. Ground the oscilloscope with the proper three-pronged power cord.
 - b. Learn to recognize potentially dangerous electrical components.
 - c. Avoid touching exposed connections in a circuit being tested even if the power is off.
 - d. All the above.
2. Grounding an oscilloscope is necessary:
 - a. For safety reasons.
 - b. To provide a reference point for making measurements.
 - c. To align the trace with the screen's horizontal axis.
 - d. All the above.
3. Circuit loading is caused by:
 - a. An input signal having too large a voltage.
 - b. The probe and oscilloscope interacting with the circuit being tested.
 - c. A 10X attenuator probe being uncompensated.
 - d. Putting too much weight on a circuit.
4. Compensating a probe is necessary to:
 - a. Balance the electrical properties of the 10X attenuator probe with the oscilloscope.
 - b. Prevent damaging the circuit being tested.
 - c. Improve the accuracy of your measurements.
 - d. All the above.
5. The trace rotation control is useful for:
 - a. Scaling waveforms on the screen.
 - b. Detecting sine wave signals.
 - c. Aligning the waveform trace with the screen's horizontal axis on an analog oscilloscope.
 - d. Measuring pulse width.

6. The volts per division control is used to:
 - a. Scale a waveform vertically.
 - b. Position a waveform vertically.
 - c. Attenuate or amplify an input signal.
 - d. Set the numbers of volts each division represents.
7. Setting the vertical input coupling to ground does the following:
 - a. Disconnects the input signal from the oscilloscope.
 - b. Causes a horizontal display to appear on the screen.
 - c. Lets you see where zero volts is on the screen.
 - d. All the above.
8. The trigger is necessary to:
 - a. Stabilize repeating waveforms on the screen.
 - b. Capture single-shot waveforms.
 - c. Mark a particular point of an acquisition.
 - d. All the above.
9. The difference between auto and normal trigger mode is:
 - a. In normal mode the oscilloscope only sweeps once and then stops.
 - b. In normal mode the oscilloscope only sweeps if the input signal reaches the trigger point; otherwise the screen is blank.
 - c. Auto mode makes the oscilloscope sweep continuously even without being triggered.
 - d. All the above.
10. A digital oscilloscope's acquisition controls let you specify:
 - a. Whether the oscilloscope uses real-time or equivalent-time sampling to collect sample points.
 - b. Whether to average a collection of records to form a waveform.
 - c. How sample points are processed to form waveform points.
 - d. All the above.
11. The acquisition mode that best reduces noise in a repeating signal is:
 - a. Sample mode.
 - b. Peak detect mode.
 - c. Envelope mode.
 - d. Averaging mode.

12. The two most basic measurements you can make with an oscilloscope are:
 - a. Time and frequency measurements.
 - b. Time and voltage measurements.
 - c. Voltage and pulse width measurements.
 - d. Pulse width and phase shift measurements.
13. If the volts/division is set at 0.5, the largest signal that can fit on the screen (assuming an 8×10 division screen) is:
 - a. 62.5 millivolts peak-to-peak.
 - b. 8 volts peak-to-peak.
 - c. 4 volts peak-to-peak.
 - d. 0.5 volts peak-to-peak.
14. If the seconds/division is set at 0.1 ms, the amount of time represented by the width of the screen is:
 - a. 0.1 ms.
 - b. 1 ms.
 - c. 1 second.
 - d. 0.1 kHz.
15. By convention, pulse width is measured:
 - a. At 10% of the pulse's maximum voltage.
 - b. At 50% of the pulse's maximum voltage.
 - c. At 90% of the pulse's maximum voltage.
 - d. At 10% and 90% of the pulse's maximum voltage.
16. You attach a probe to your test circuit but the screen is blank. You should:
 - a. Check that the screen intensity is turned up.
 - b. Check that the oscilloscope is set to display the channel that the probe is connected to.
 - c. Set the trigger mode to auto since norm mode blanks the screen.
 - d. Set the vertical input coupling to AC and set the volts/division to its largest value since a large DC signal may go off the top or bottom of the screen.
 - e. Check that the probe isn't shorted and make sure it is properly grounded.
 - f. Check that the oscilloscope is set to trigger on the input channel you are using.

Answers to the written exercises are on the back of this sheet.

Written Exercise Answers

This section provides the answers to all written exercises in the previous sections.

Part I: Vocabulary Exercise Answers

1. L	5. D	9. G	13. I
2. M	6. J	10. F	14. K
3. O	7. E	11. H	15. B
4. N	8. C	12. P	16. A

Part I: Oscilloscope Usage Exercise Answers

1. D	3. D	5. D	7. D
2. B,D	4. C	6. A,B	8. A,B,D

Part II: Vocabulary Exercise Answers

1. G	4. H	7. J	10. F
2. A	5. B	8. I	11. K
3. L	6. D	9. C	12. E

Part II: Oscilloscope Usage Exercise Answers

1. D	5. C	9. B,C	13. C
2. A,B	6. A,C,D	10. D	14. B
3. B	7. D	11. D	15. B
4. A,C	8. D	12. B	16. G

Glossary

AC

(Alternating Current) A signal in which the current and voltage vary in a repeating pattern over time.

ADC

(Analog-to-Digital Converter) A digital electronic component that converts an electrical signal into discrete binary values.

Alternate Mode

A display mode of operation in which the oscilloscope completes tracing one channel before beginning to trace another channel.

Amplitude

The magnitude of a quantity or strength of a signal. In electronics, amplitude usually refers to either voltage or power.

Attenuation

A decrease in signal voltage during its transmission from one point to another.

Averaging

A processing technique used by digital oscilloscopes to eliminate noise in a signal.

Bandwidth

A frequency range.

CRT

(Cathode-Ray Tube) An electron-beam tube in which the beam can be focused on a luminescent screen and varied in both position and intensity to produce a visible pattern. A television picture tube is a CRT.

Chop Mode

A display mode of operation in which small parts of each channel are traced so that more than one waveform can appear on the screen simultaneously.

Circuit Loading

The unintentional interaction of the probe and oscilloscope with the circuit being tested, distorting the signal.

Compensation

A probe adjustment for 10X probes that balances the capacitance of the probe with the capacitance of the oscilloscope.

Coupling

The method of connecting two circuits together. Circuits connected with a wire are directly coupled; circuits connected through a capacitor or a transformer are indirectly (or AC) coupled.

Cursor

An on-screen marker that you can align with a waveform to take accurate measurements.

DC (Direct Current)

A signal with a constant voltage and current.

Division

Measurement markings on the CRT graticule of the oscilloscope.

Earth Ground

A conductor that will dissipate large electrical currents into the Earth.

Envelope

The outline of a signal's highest and lowest points acquired over many repetitions.

Equivalent-time Sampling

A sampling mode in which the oscilloscope constructs a picture of a repetitive signal by capturing a little bit of information from each repetition.

Focus

The oscilloscope control that adjusts the CRT electron beams to control the sharpness of the display.

Frequency

The number of times a signal repeats in one second, measured in Hertz (cycles per second). The frequency equals $1/\text{period}$.

Gigahertz (GHz)

1,000,000,000 Hertz; a unit of frequency.

Glitch

An intermittent error in a circuit.

Graticule

The grid lines on a screen for measuring oscilloscope traces.

Ground

1. A conducting connection by which an electric circuit or equipment is connected to the earth to establish and maintain a reference voltage level.
2. The voltage reference point in a circuit.

Hertz (Hz)

One cycle per second; the unit of frequency.

Kilohertz (kHz)

1000 Hertz; a unit of frequency.

Interpolation

A "connect-the-dots" processing technique to estimate what a fast waveform looks like based on only a few sampled points.

Megahertz (MHz)

1,000,000 Hertz; a unit of frequency.

Megasamples per second (MS/s)

A sample rate unit equal to one million samples per second.

Microsecond (μs)

A unit of time equivalent to 0.000001 seconds.

Millisecond (ms)

A unit of time equivalent to 0.001 seconds.

Nanosecond (ns)

A unit of time equivalent to 0.000000001 seconds.

Noise

An unwanted voltage or current in an electrical circuit.

Oscilloscope

An instrument used to make voltage changes visible over time. The word oscilloscope comes from "oscillate," since oscilloscopes are often used to measure oscillating voltages.

Peak (V_p)

The maximum voltage level measured from a zero reference point.

Peak-to-peak (V_{p-p})

The voltage measured from the maximum point of a signal to its minimum point, usually twice the V_p level.

Peak Detection

An acquisition mode for digital oscilloscopes that lets you see the extremes of a signal.

Period

The amount of time it takes a wave to complete one cycle. The period equals $1/\text{frequency}$.

Phase

The amount of time that passes from the beginning of a cycle to the beginning of the next cycle, measured in degrees.

Probe

An oscilloscope input device, usually having a pointed metal tip for making electrical contact with a circuit element and a flexible cable for transmitting the signal to the oscilloscope.

Pulse

A common waveform shape that has a fast rising edge, a width, and a fast falling edge.

RMS

Root mean square.

Real-time Sampling

A sampling mode in which the oscilloscope collects as many samples as it can as the signal occurs.

Record Length

The number of waveform points used to create a record of a signal.

Rise Time

The time taken for the leading edge of a pulse to rise from its minimum to its maximum values (typically measured from 10% to 90% of these values).

Sample Point

The raw data from an ADC used to calculate waveform points.

Screen

The surface of the CRT upon which the visible pattern is produced — the display area.

Signal Generator

A test device for injecting a signal into a circuit input; the circuit's output is then read by an oscilloscope.

Sine Wave

A common curved wave shape that is mathematically defined.

Single Shot

A signal measured by an oscilloscope that only occurs once (also called a transient event).

Single Sweep

A trigger mode for displaying one screenful of a signal and then stopping.

Slope

On a graph or an oscilloscope screen, the ratio of a vertical distance to a horizontal distance. A positive slope increases from left to right, while a negative slope decreases from left to right.

Square Wave

A common wave shape consisting of repeating square pulses.

Sweep

One horizontal pass of an oscilloscope's electron beam from left to right across the CRT screen.

Sweep Speed

Same as the time base.

Time Base

Oscilloscope circuitry that controls the timing of the sweep. The time base is set by the seconds/division control.

Trace

The visible shapes drawn on a CRT by the movement of the electron beam.

Transducer

A device that converts a specific physical quantity such as sound, pressure, strain, or light intensity into an electrical signal.

Transient

A signal measured by an oscilloscope that only occurs once (also called a single-shot event).

Trigger

The circuit that initiates a horizontal sweep on an oscilloscope and determines the beginning point of the waveform.

Trigger Holdoff

A control that inhibits the trigger circuit from looking for a trigger level for some specified time after the end of the waveform.

Trigger Level

The voltage level that a trigger source signal must reach before the trigger circuit initiates a sweep.

Volt

The unit of electric potential difference.

Voltage

The difference in electric potential, expressed in volts, between two points.

Waveform

A graphic representation of a voltage varying over time.

Waveform Point

A digital value that represents the voltage of a signal at a specific point in time. Waveform points are calculated from sample points and stored in memory.

Z-axis

The signal in an oscilloscope that controls electron-beam brightness as the trace is formed.

A

Abbreviations, defined
AC, G-1
ADC, G-1
CRT, G-1
DC, G-2
GHz, G-2
Hz, G-2
kHz, G-2
MHz, G-2
 μ s, G-3
ms, G-3
MS/s, G-3
ns, G-3
RMS, G-3
Vp, G-3
Vp-p, G-3

AC, 15
defined, G-1

Acquisition controls, 39

Acquisition modes, 39
averaging, 40
envelope, 40
hi res, 40
peak detect, 40
sample, 39

Acquisition system, 8

Active probes, 25

ADC, 6
defined, G-1

ADC resolution, 20

Add mode, 32

Alternate display mode, 31

Alternating mode, defined, G-1

Amplifier, 7

Amplitude, defined, G-1

Analog oscilloscopes, 7

Attenuation, defined, G-1

Attenuator, 7

Auto trigger, 37

Autoset, 22

Averaging, 40
defined, G-1

B

Bandwidth, 19
defined, G-1

Bandwidth limit, 31

C

Calculations
current, 44
power, 44
resistance, 44
voltage, 44

Channel invert, 31

Chop display mode, 31

Chop mode, defined, G-1

Circuit loading, 23, 25
defined, G-1

Compensation, defined, G-1

Control settings, Typical, 23

Controls
horizontal, 22
trigger, 22
vertical, 22

Converter, Analog-to-digital, 6

Coupling
AC, 30
DC, 30
defined, G-1
Ground, 30

CRT, 7
defined, G-1

Current probes, 25

Cursor, defined, G-2

Cursors, 45

Cycle, 13

D

DC, 15
defined, G-2

Delayed trigger, 33

Digital oscilloscopes, 8

Display controls, 29

Division, defined, G-2

Divisions, 43

E

Earth ground, 21
defined, G-2

Envelope, 40
defined, G-2

Equivalent-time sampling, 11
defined, G-2

F

False triggering, eliminating, 37

Focus, defined, G-2

Focus control, 29

Frequency, 17
defined, G-2

Frequency measurements, 45

Frequency ratios, 47

Front panel controls, 22

G

- Gain accuracy, 19
- Gigahertz, defined, G-2
- Glitch, 16
 - defined, G-2
- Graticule, 43
 - defined, G-2
- Ground, defined, G-2
- Ground clip, 25
- Grounding strap, 21
- Grounding the oscilloscope, 21
- Grounding yourself, 21

H

- Hertz, defined, G-2
- Hi res, 40
- Horizontal
 - position, 33
 - time base, 7
- Horizontal accuracy, 19
- Horizontal controls, 33
- Horizontal system, 7

I

- Input connectors, 22
- Input coupling, 30
- Intensity control, 29
- Interpolation, 10
 - defined, G-2
- Invert, 32

K

- Kilohertz, defined, G-2

L

- Lissajous patterns, 47

M

- Magnification, horizontal, 34
- Math operations
 - adding waveforms, 32
 - subtracting waveforms, 32
- Measurement terms, 13
- Measurements
 - frequency, 45
 - peak, 44
 - peak-to-peak, 44
 - period, 45
 - pulse width, 45
 - rise time, 43
 - time, 45
 - voltage, 44
- Megahertz, defined, G-2
- Megasamples per second, defined, G-3
- Microsecond, defined, G-3
- Millisecond, defined, G-3

N

- Nanosecond, defined, G-3
- Noise, defined, G-3
- Normal, 37

O

- Ohm's law, 44
- Oscilloscope
 - defined, G-3
 - what is it, 3

- Oscilloscopes
 - analog, 7
 - digital, 8
 - digital and analog, 6
 - how they work, 7
 - purpose of, 5

P

- Passive probes, 24
- Peak, defined, G-3
- Peak detect, 40
- Peak detection, defined, G-3
- Peak-to-peak, 17, 44
 - defined, G-3
- Percent markings, 43
- Performance terms, 19
- Period, 17
 - defined, G-3
- Phase, 18
 - defined, G-3
- Phase shift, 18
- Phase shift measurements, 47
- Power law, 44
- Preset, 22
- Pretrigger, 9
 - defined, 34
- Probe, defined, G-3
- Probe compensation
 - how to, 26
 - what is it, 24
- Probes, 23
- Pulse, 16
 - defined, G-3
- Pulse measurements, 46
- Pulse train, 16

16
 sam
 3 sar
 ad, G-
 , 9
 J length
 ined, G-
 .angular w
 solution, 20
 se time, 19
 defined, G-4
 IMS, defined, C

S

Safety, 21
 Sample, 39
 Sample point, 39
 defined, G-4
 Sample points, 8
 Sample rate, 8
 maximum, 20
 Sampling
 equivalent-time,
 interpolation, 10
 real-time, 10
 Sampling modes, 71
 Sawtooth wave, 16
 Scale, 43
 Screen, defined, G-4
 Seconds per division,
 Sequential sampling, 7
 Signal generator, defined, 4
 Sine wave, defined, G-4
 Sine waves, 15
 damped, 15
 Single shot, defined, G-4
 Single sweep, defined, G-4
 Single-shot, 16
 Slope, defined, G-4

Square wave, 15
 defined, G-4
 Static electricity, 21
 Step, 16
 Sweep, defined, G-4
 Sweep speed, 19
 defined, G-4

T

Terminology, 13- 20
 Time base, 7, 33
 defined, G-4
 delayed, 33
 main, 33
 Time base accuracy, 19
 Time measurements, 45
 Trace, defined, G-4
 Trace rotation, 29
 Transducer, 5
 defined, G-4
 Transient, 16
 defined, G-4
 Triangle wave, 16
 Trigger
 defined, G-5
 types, 36
 Trigger controls, 35
 Trigger coupling
 AC, 37
 DC, 37
 high frequency reject, 37
 Low frequency reject, 37
 noise reject, 37
 Trigger holdoff, 38
 defined, G-5
 Trigger level, 36
 defined, G-5
 Trigger modes
 auto, 37
 normal, 37
 Trigger position, horizontal, 34
 Trigger slope, 36
 Trigger source, 36

Trigger system, 7

V

Variable gain, 30
 Vertical, position control, 30
 Vertical controls, 29
 Vertical resolution, 20
 Vertical scale, 30
 Vertical sensitivity, 19
 Vertical system, 7
 Volt, defined, G-5
 Voltage, 17
 defined, G-5
 peak, 44
 peak-to-peak, 44
 rms, 44
 Voltage measurement
 using cursors, 45
 using graticule, 44
 Voltage measurements, 44
 Volts per Division control, 30

W

Waveform, 13
 defined, G-5
 Waveform point, defined, G-5
 Waveform points, 9, 39

X

XY mode, 34, 47

Z

Z-axis, defined, G-5